

DESKY

Liberty[®]



Liberty, with Form-Sensing Mesh Technology, is unlike any mesh chair you've seen or experienced. With its tri-panel construction, Liberty has the body-fitting contours that single-panel stretch mesh chairs simply can't achieve. And it offers perfect lumbar support and balanced recline for everyone, without external devices or manual adjustments.

Liberty[™]



Designed by Niels Diffrient

Niels Diffrient's designs are grounded in the philosophy of form flowing from function. His work spanned generations. He consistently looked past trends to reinvent tools we use for daily living. Diffrient channeled his knowledge of engineering, architecture and human factors into the creation of highly functional and aesthetically timeless designs.





“When you look at the tailored stitching, you immediately see that Niels’ inspiration is the tailored shirt—beautiful, simple, functional. That’s industrial design at its best.”

—Susan S. Szenasy, Editor-in-Chief, Metropolis



Office Seating

Liberty's mesh back is formed by combining three panels of low-stretch mesh in the same way a tailor combines multiple pieces of material to form a shirt. So its contours are custom-made to both fit and support the human body in unprecedented comfort. Liberty has set a new bar for performance, simplicity, elegance and comfort.

Liberty's Features and Innovations

1 Self-Adjusting Recline

- Intelligent counter-balance recline mechanism automatically provides the right amount of support through the full range of recline motion, regardless of user size and weight
- No tension springs to adjust
- No recline locks to set/release
- During recline, the angle between torso and legs opens up for better body function
- User maintains near constant eye level during recline

2 Pivoting Backrest

- Extra motion of the backrest during recline automatically adjusts to the changing needs of the spine
- Provides additional lumbar support as needed

3 Form-Sensing Mesh Back

- Tri-panel, non-stretch mesh construction creates body-fitting contours and self-adjusting lumbar support for a customized fit
- No external lumbar devices to adjust, break or lose
- Low-abrasion mesh protects clothing
- Modular for easy replacement

4 Contoured Seat Cushion

- Carefully sculpted to match body contours
- Increased contact area reduces pressure points
- Modular for easy replacement

5 Armrest Options

- Adjustable or fixed armrests connect to the backrest instead of the seat so they stay with the body during recline
- Armless model also available

6 Body Fit

- Size-adjustable to fit more than 95% of the population
- Automatic adjustments
 - Weight-sensitive recline
 - Form-sensing lumbar support
- Manual adjustments
 - Optional height-adjustable armrests
 - Seat height
 - Seat depth

7 Casters

- 3" dual-surface casters roll easily on carpeted floors and quietly on hard floors

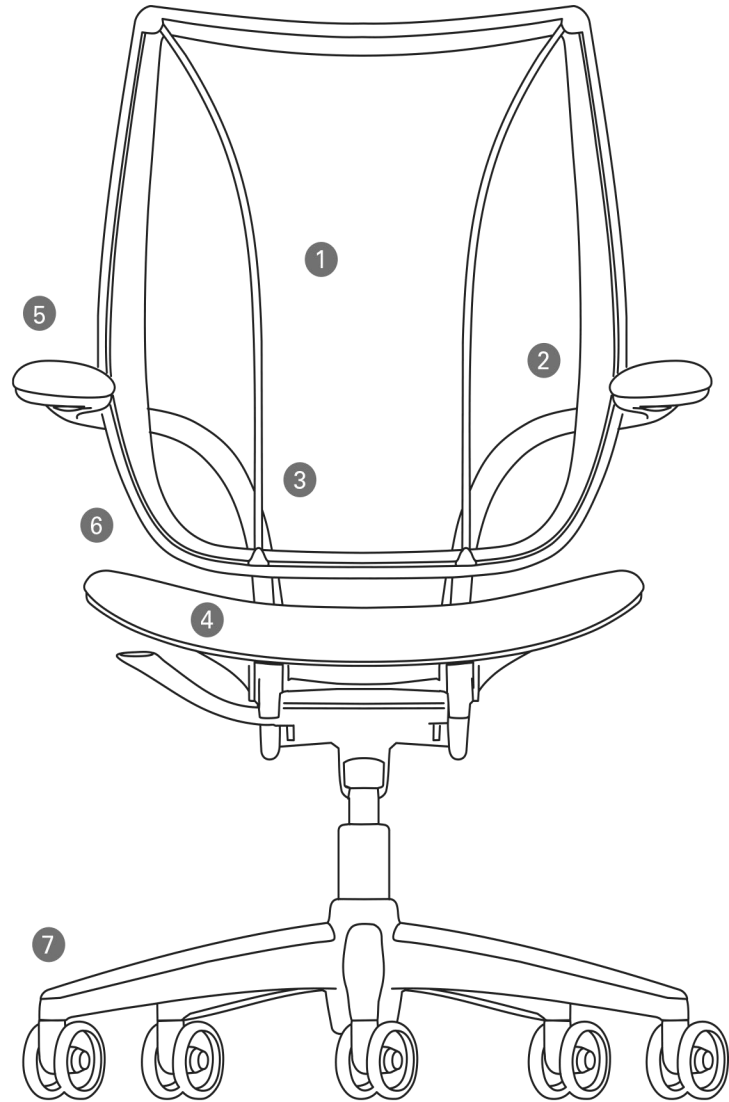

Liberty's automatic fit and ease of use make it the perfect choice for conference room seating, where every occupant will feel comfortable and supported without having to worry about adjustments.







Side Seating

Designed to complement the features and styling of the Liberty office chair, the Side chair offers beauty, performance and unprecedented comfort in its class. Its backrest features Liberty's exclusive Form-Sensing Mesh Technology for perfect fit and support. The backrest pivots for additional comfort, and the seat has a frameless front edge that is supportive, yet soft.

The Critics Have Spoken

"Unlike most so-called ergonomic seating, the Liberty is actually comfortable ... [and] shockingly beautiful!"

—**Newsday**

"Beautiful, simple, functional ... industrial design at its best."

—Susan S. Szenasy, Editor-in-Chief, **Metropolis**

"With its graceful curved arms and no-nonsense design ... Liberty is one of the most beautiful office chairs ever created."

—**The Grand Rapids Press**

"Dynamic in looks and performance."

—**Buildings Magazine**, "Editors' Choice, Top 100 Products"

"The best new gear of the year."

—**Men's Journal**

"I can't say enough about this chair. Liberty is as functional as it is elegant. This sit is the bomb."

—**Slate**

Liberty Awards





Revolutionary Mesh

Liberty's translucent mesh textiles were designed by Elizabeth Whelan to provide optimal ergonomic support and comfort by melding strength, flexibility and resiliency. They surpass the performance criteria for contract seating textiles and meet a variety of environmental standards in both the United States and Europe. They have a pleasing hand that is gentle to the touch. In fact, these mesh offerings were specifically designed to be gentle on your clothes as well.



*Elizabeth Whelan,
Textile Designer*

I.D.

2005 Annual
Design Review
Winner

Center Frame Construction

Liberty's mesh is secured in a channel in the center of the backrest frame. In this way, the frame protects the mesh from impacts and abrasions.

Mesh Colors and Patterns

Monofilament Stripe

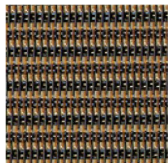

Amber

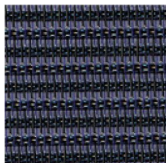

Atlantic

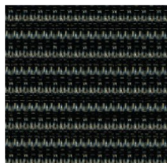

Black

Silver Check

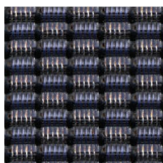

Sapphire

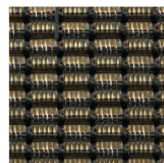

Topaz

Torque*

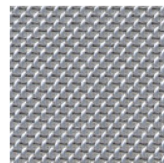

Aluminum



Black

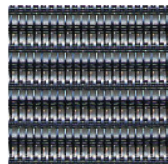

Carbon



Green

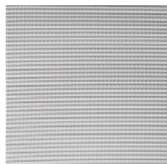

Platinum

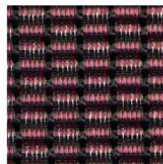

Ruby

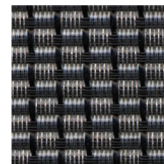

Alloy

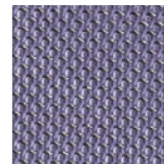

Lagoon

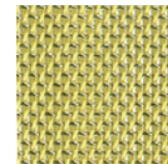

Soleil

*Available only on Liberty Task and Conference chairs

Liberty and the Environment

Humanscale is committed to environmental sustainability and continually strives to design, engineer and manufacture products that—compared to others in the same class—consume less of the Earth's limited resources. This is accomplished by creating products that:

- Weigh less and require less raw material
- Ship as efficiently as possible
- Have timeless design and durable construction so they have to be replaced less frequently
- Are engineered to be easily recyclable

Here are some of the environmental highlights for the Liberty chair

- Weighs as little as 40 lbs, minimizing carbon footprint in shipping
- Contains recycled content
- Designed for easy disassembly with clear recycling guidelines
- Ships in recycled packaging, or blanket-wrapped, when feasible
- Certified by GREENGUARD and BIFMA level®
- Can earn points toward LEED Certification in a number of areas



Proud Supporter of:



Liberty[®]



DESKY

AVAILABLE AT DESKY

w: deskycommercial.com.au