

# Product Information

## Massage Bathtub

en

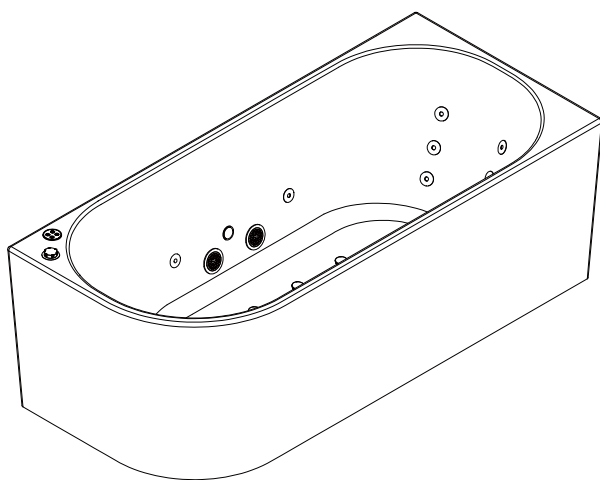

# Lindo

1700 x 780 x 600mm

Please record your  
Spa Bath Serial Number here.

\* Spa Bath serial number is located on the galvanized steel frame.

## English

If you have any questions regarding installation, maintenance or usage of your product please contact the seller for detailed information.

**Please Note: If you need any service  
please contact ENTREND DESIGN  
TEL: (02) 96006166**

## Installation & User Manual

---

---

**⚠ Warning!** Risk of fire, electric shock and water leakage.

**i** Your massage bathtub includes a detailed Installed Installation & User Manual. Follow all instructions in the Installation & User Manual closely.

**⚠ Warning!** In-proper installation, usage or maintenance can lead to loss of warranty, injury or property damage.

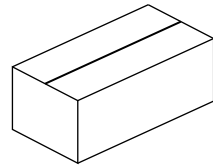

Spa Bath to be installed in accordance with BCA and local regulatory standards by qualified persons only. An isolation switch is recommended.

Electrical installation must comply with AS:3000-Electrical Wiring Rules.

## Suggested Tools For Installation

---

---

The following tools are required to install your bathtubs. Additional tools may be required depending on the installation circumstances.

1. Water level
2. Sealant
3. Adjustable spanner or spanner in required sizes
4. Screw driver
5. PTFE sealing tape or suitable substitute

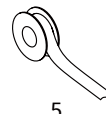
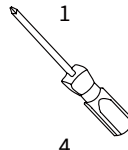
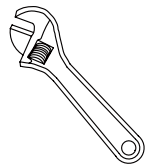
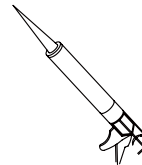
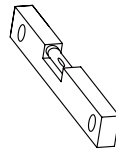

# Installation

---

1. **Silicon on top.**
2. **Do Not apply silicon sealant around the bottom base of the spa.**

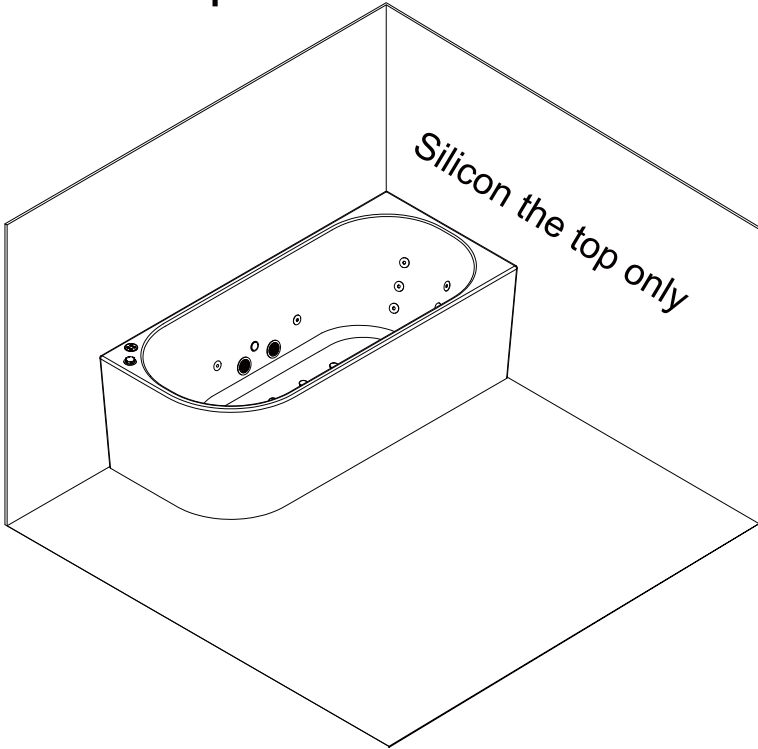

3. **Do Not, install any fixed shower screen panel directly onto the spa bath.**
4. **No shower over or adjacent to the spa bath. This product is a spa bath only.**

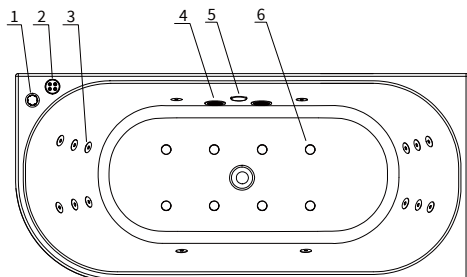

## Product Description



By default the massage bathtub is equipped with the following features as indicated in the illustration above:

1. Regulator
2. Touch control pad
3. Water jets
4. Suction
5. Underwater light
6. Air jets

### Touch Pad Usage Instructions

1.  **On/off:**  
Press this button, the system will start, the indicator light will be on; Press this button again, the system will be closed and the indicator light will be off.
2.  **Water pump function:**  
This function is controlled by the water level and will not be activated until the system detects the water. And the indicator light will flash when there is not enough water. After the pump is started, it will be automatically shut down after 60 minutes working.
3.  **Wind pump function:**  
It is not controlled by the water level. It also will be automatically shut down after 60 minutes working.

-  The massage bathtub may be available with additional specification options which may have been fitted on your bathtub. Please contact the seller if you are unsure about the fitted options.

Due to technological advance features on the bathtub may have been upgraded or the position optimized by the manufacturer. Installed features shown on the illustration are symbolic and for clarification only.

-  Carefully check the product specification to ensure that the bathtub is the model that you ordered. Do not install the bathtub if it is different from the model you ordered.

### Electric Parameters

- |                          |             |
|--------------------------|-------------|
| ① Rated Voltage:         | 220 - 240 V |
| ② Rated Frequency:       | 50 / 60 Hz  |
| ③ Rated Maximum Power:   | 800W        |
| ④ Rated Maximum Current: | 3.6A        |

 **Warning!** Risk of fire and electric shock. All electrical connections should be made by a licensed, locally certified electrician, in accordance with the requirements of the national electrical codes and procedures.

### Panel function description



4.  **Underwater lamp function:**  
Press this button can turn on / off the underwater lamp.

# Installation

## System wiring diagram

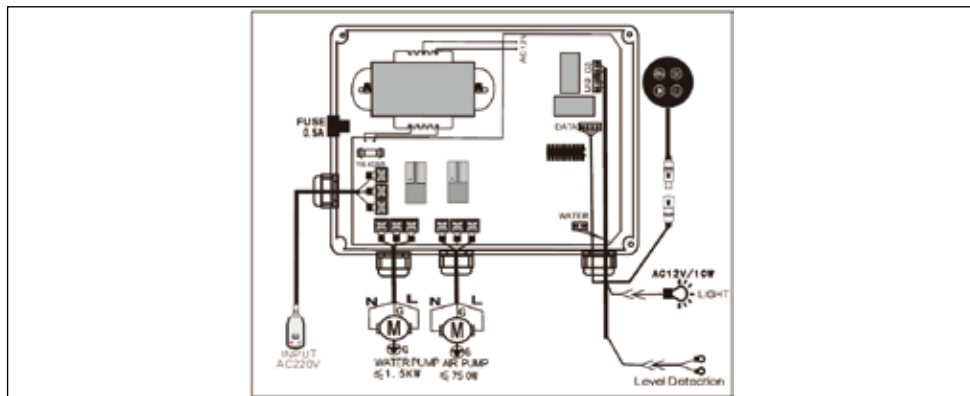

**i** Your massage bathtub includes a detailed Installed Installation & User Manual. Follow all instructions in the Installation & User Manual closely.

### Electric Parameters

- ① Rated Voltage: 220 - 240 V
- ② Rated Frequency: 50 / 60 Hz
- ③ Rated Maximum Power: 800 W
- ④ Rated Maximum Current: 3.6 A

### Preparation of Connections

**i** Due to technical advance positioning of relevant connections on the bathtub may be optimized. Literature dimensions are for reference only. Installation dimensions should be taken directly from the tub.

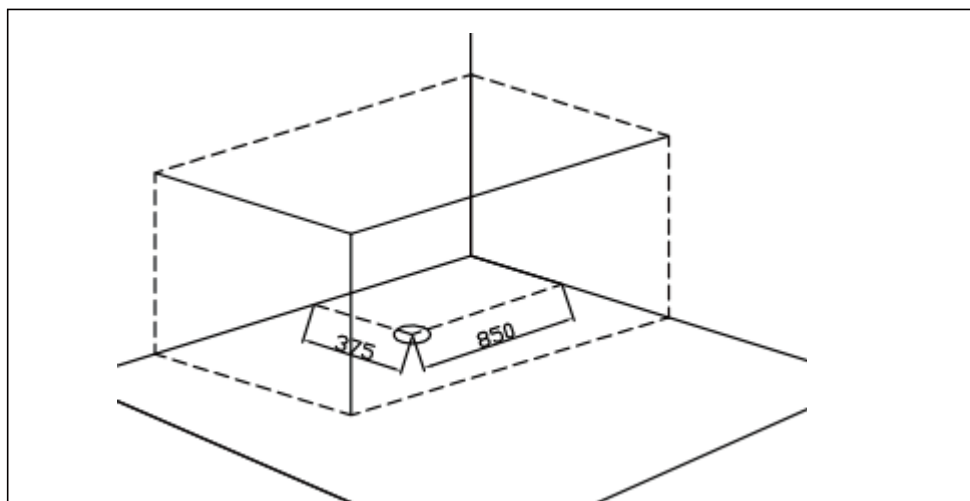

Connection Position Chart

# Installation

---

1. As the picture shows below, turn over the bathtub, wrap the drainer hole with thread PTFE tape, and then screw the drainer. We recommend using a Flexible Connector. Ensure the Flexible Connector is cut to the correct length for easier installation & to prevent drainage issues.

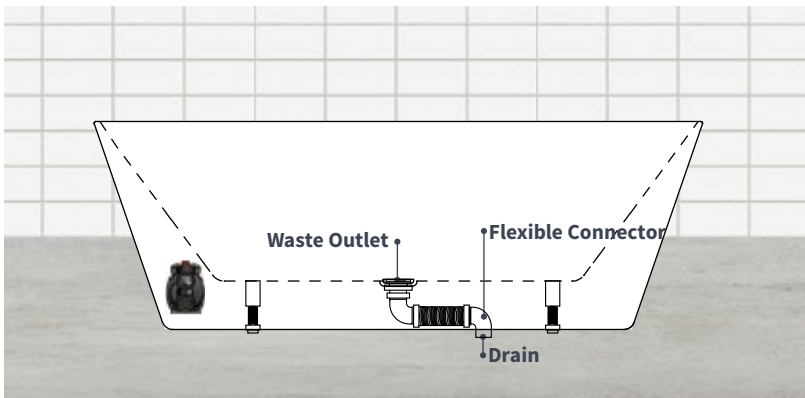
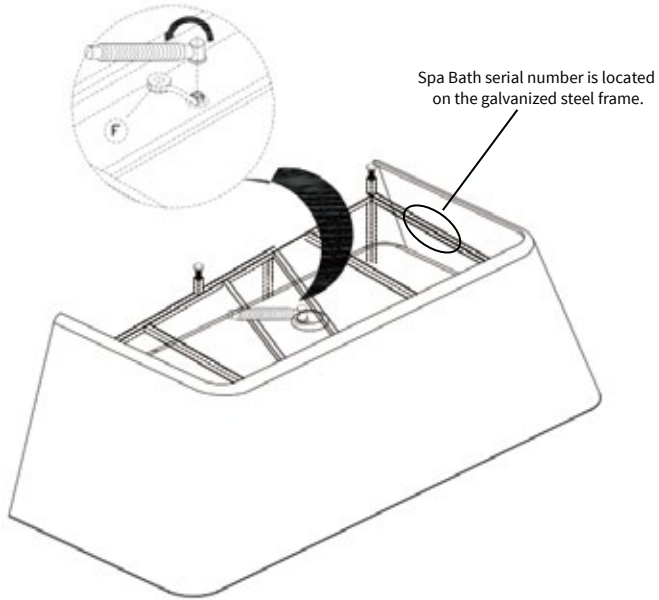

## Usage

---

1. Switch on the power supply
2. Let water in.
3. Don't press the water pump switch unless the water level in the bathtub reaches higher than the jets position.
4. Press the touch control pad and switch the regulator to adjust the intensity of the jets.
5. Press the touch control pad, turn off the pumps and drain the water after use.
6. Then turn off the power supply.

## Troubleshooting

---

Trouble	Possible Reason	Try this to solve
Water pump Don't work.	Power supply is not well connected, the leakage protector disconnected.	Turn on the power supply, and connect the leakage protector.
	Water pump impeller was stuck by sundries.	Clean the water pump impeller.
	The water pump switch is off.	Press the water pump switch.
	Power supply plug is not connected or not enough poweysuppl	Plug the power supply in.
	Water pump trouble.	Repair or replace the water pump.
Massage power can't be adjusted.	Voltage problem.	Check voltage.
	Adjust switch is off or has problem.	Check, replace the switch.
	Water Circulation is blocked.	Clean the water circulation.
Bathtub don't stand horizontally.	Adjustable foot is not well-adjusted.	Adjust the adjustable foot.
Water leakage.	Seal ring is not good.	Replace the seal ring.
	Nut is loose.	Screw down the nut.
	Connecting part is not well connected.	Pay attention to the connecting part connection.

## Cleaning & Maintenance

---

1. Should be cleaned with a soft cloth using warm soap water. Don't use detergent that with acetone or ammonia. Disinfectant with formic acid and formaldehyde is forbidden during disinfection.
2. **DO NOT USE BATH SALTS, IF SO, THIS AVOID WARRANTY.**
3. If there is scratch on the bathtub surface, use 2000# waterproof abrasive paper to polish it and lay toothpaste on. Then use soft cloth to refurbish it.
4. Scale deposit can be wiped off with warm citric acid or vinegar by a soft cloth.
5. Screw off the Water Circulation and jets for cleaning when plug up by litter, such as hair
6. Frequent cleaning is not necessary for the parts gilded and silver-gilt
7. Don't clean the tub with hard or coarse material to avoid any scratches; and don't clean the tub by detergent with chemical menstruum to avoid any damages.
8. Be sure to drain off the water and disconnect the power supply after use
9. Don't hit and score the bathtub by hard or keen-edged material. And don't touch the bathtub by cigarette end or heat source that over 70°C
10. Water massage system cleaning: fill the bathtub with 40°C hot water, and add detergent(2g/L). Then run the water massage system for 5 minutes. After that, stop the pump and drain the water. Fill the bathtub with cold water, and run the water massage system for 3 minutes. Clean the bathtub after stopping the pump and draining off the water.
11. Regular maintenance cycle is recommended. Please follow the above procedures for water massage system cleaning monthly and scale deposit cleaning as required.

## Precautions

---

1. The installation should be carried out by a qualified technician, and should be according to the manual.
2. The appliance electric parameter should be tally with the National Safety Standard. And there should be creepage protector on the power supply. Make sure the ground wire is safe. Don't touch the switch, electrical outlet and plug with water.
3. Don't use overheated water. Put cold water first, then hot water. Don't run the appliance until the water level is higher than the jets.
4. The rated voltage of this appliance is 220-240V.
5. Disconnect the power supply after use
6. Don't take a bath for a long time. Recommended time: less than 30 minutes
7. Please restart the appliance for occasional system halt
8. If the supply cord is damaged, it must be replaced by the manufacturer, its service agent or similarly qualified persons in order to avoid a hazard.
9. This manual is attached with the product. Before installation, please read it carefully. All the installation and usage should conform to this manual, to avoid damage or other accident.
10. Spa bath to be installed in accordance with BCA and local regulatory standards by qualified person only.
11. All isolation switch is recommended.
12. The non return check valve is closed under normal operating pressure. It does not require plumbing into sewer since outflow is not expected in normal conditions.

### Caution:

1. When the bathtub can't work, please check according to the troubleshooting list. If you can't judge the reason or unable to repair it, please contact us.
2. To insure the customers' safety, the installation should be carried out by a qualified technician. Please use eligible creepage protector. The ground wire should be well connected to the ground.