

Carport Installation Manual

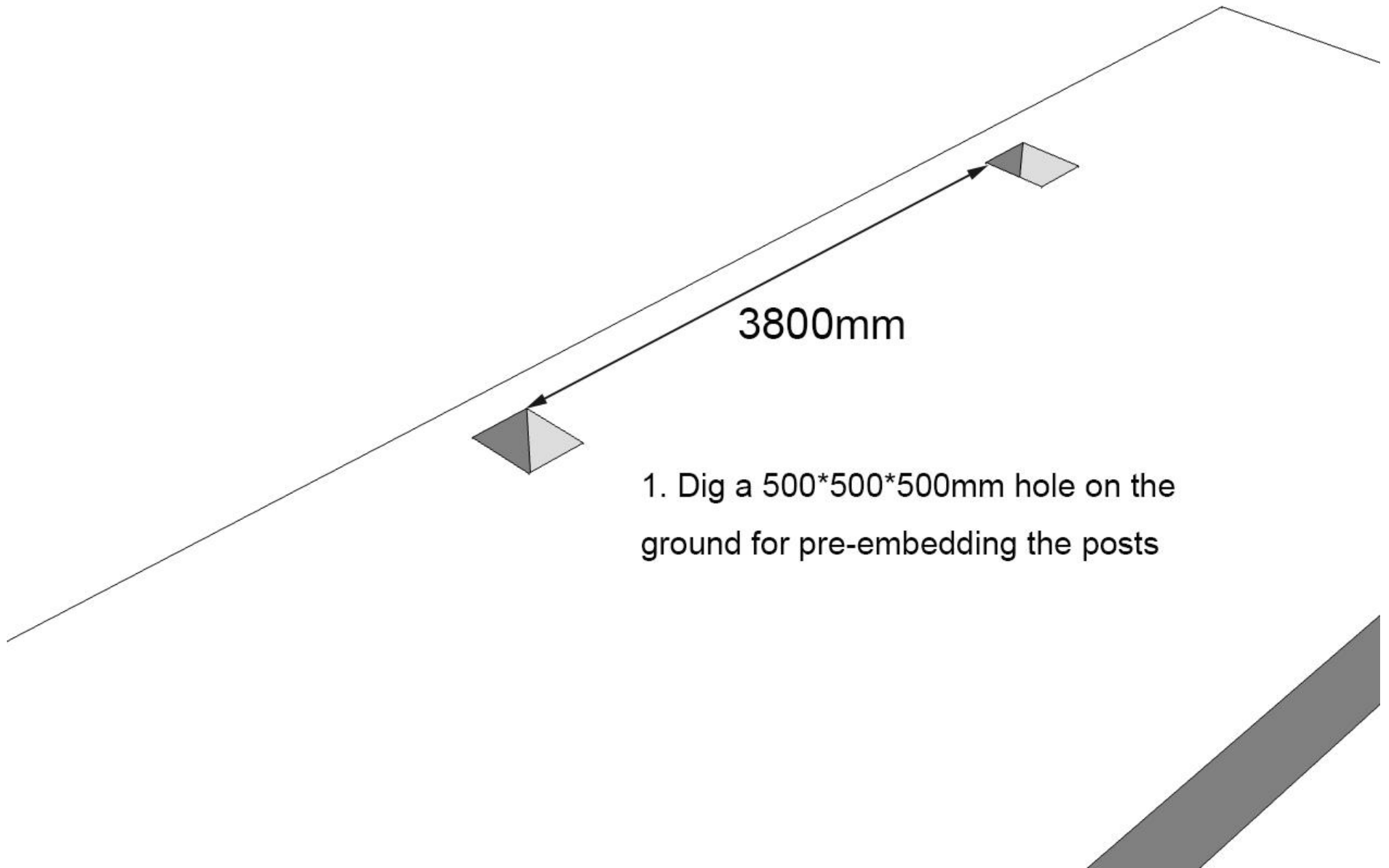

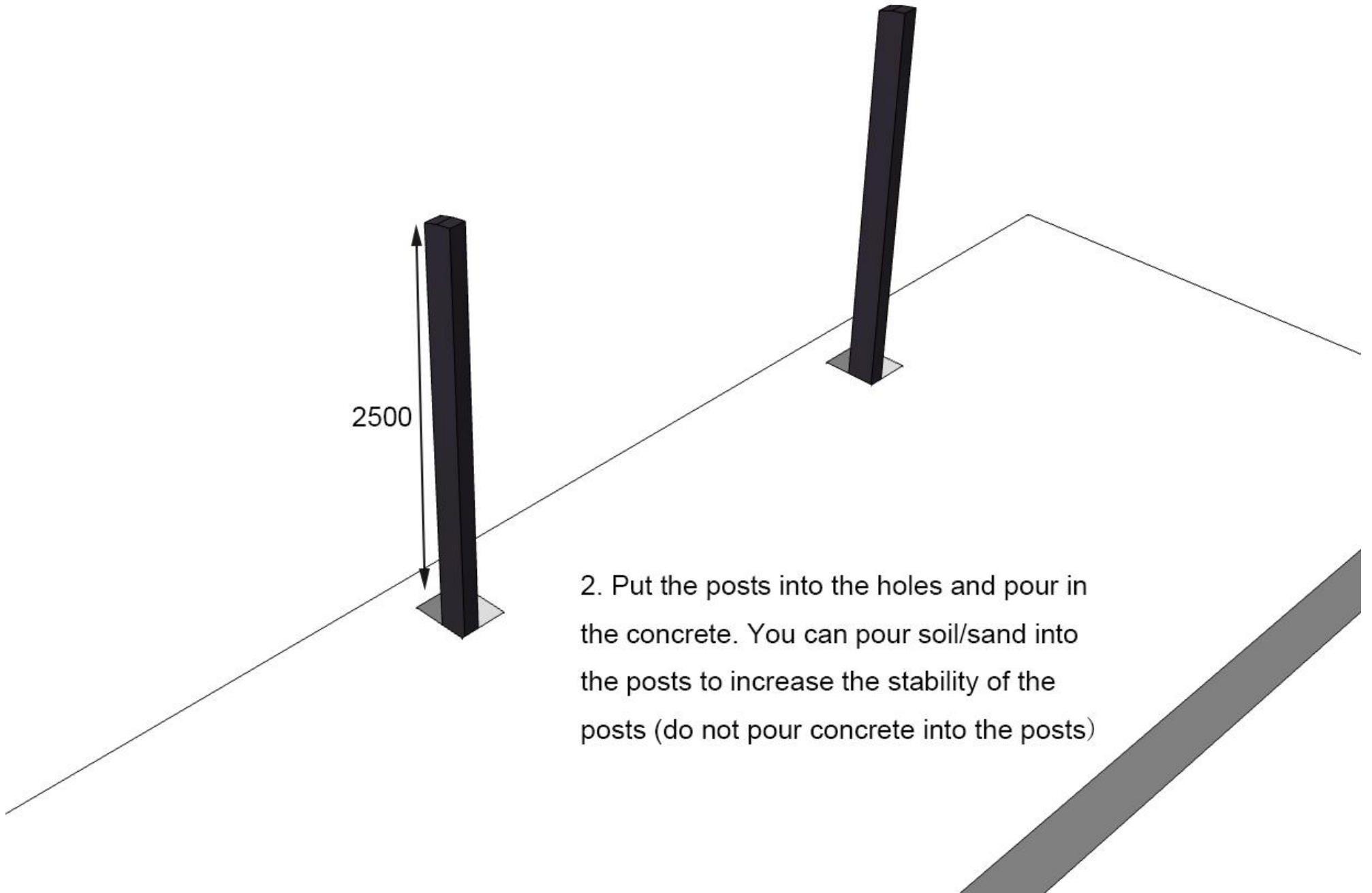

1. Dig a 500*500*500mm hole on the ground for pre-embedding the posts



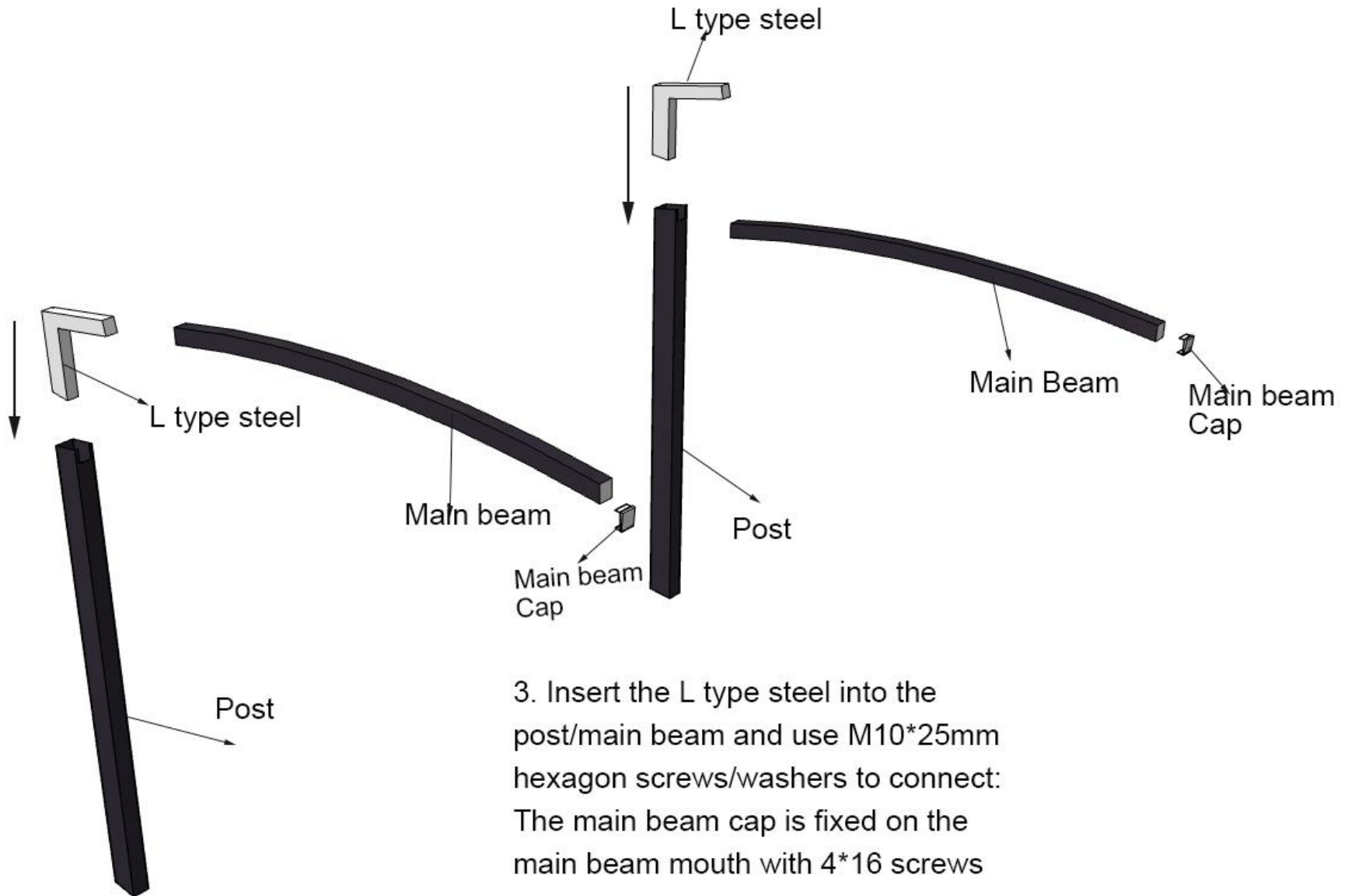

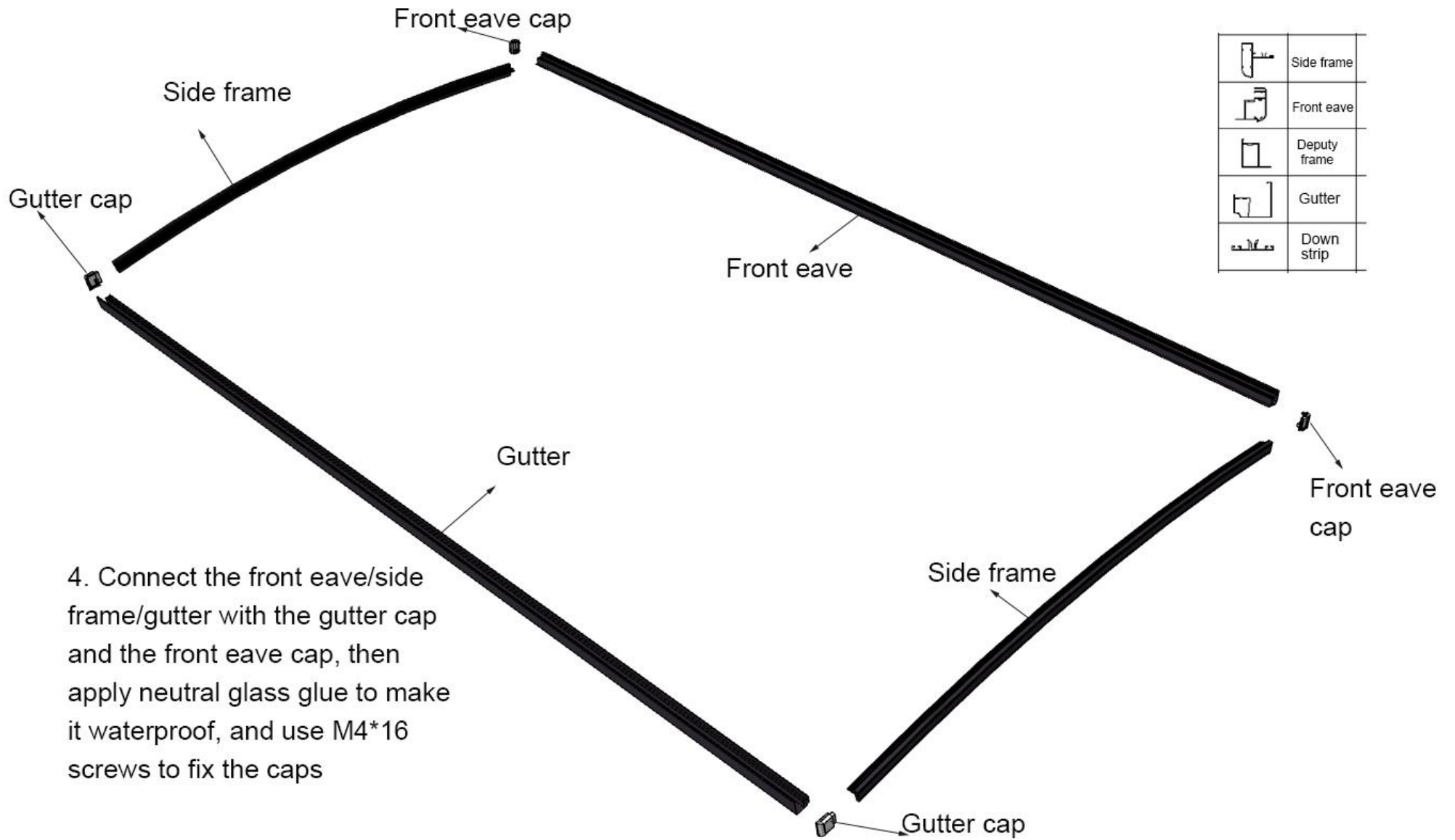



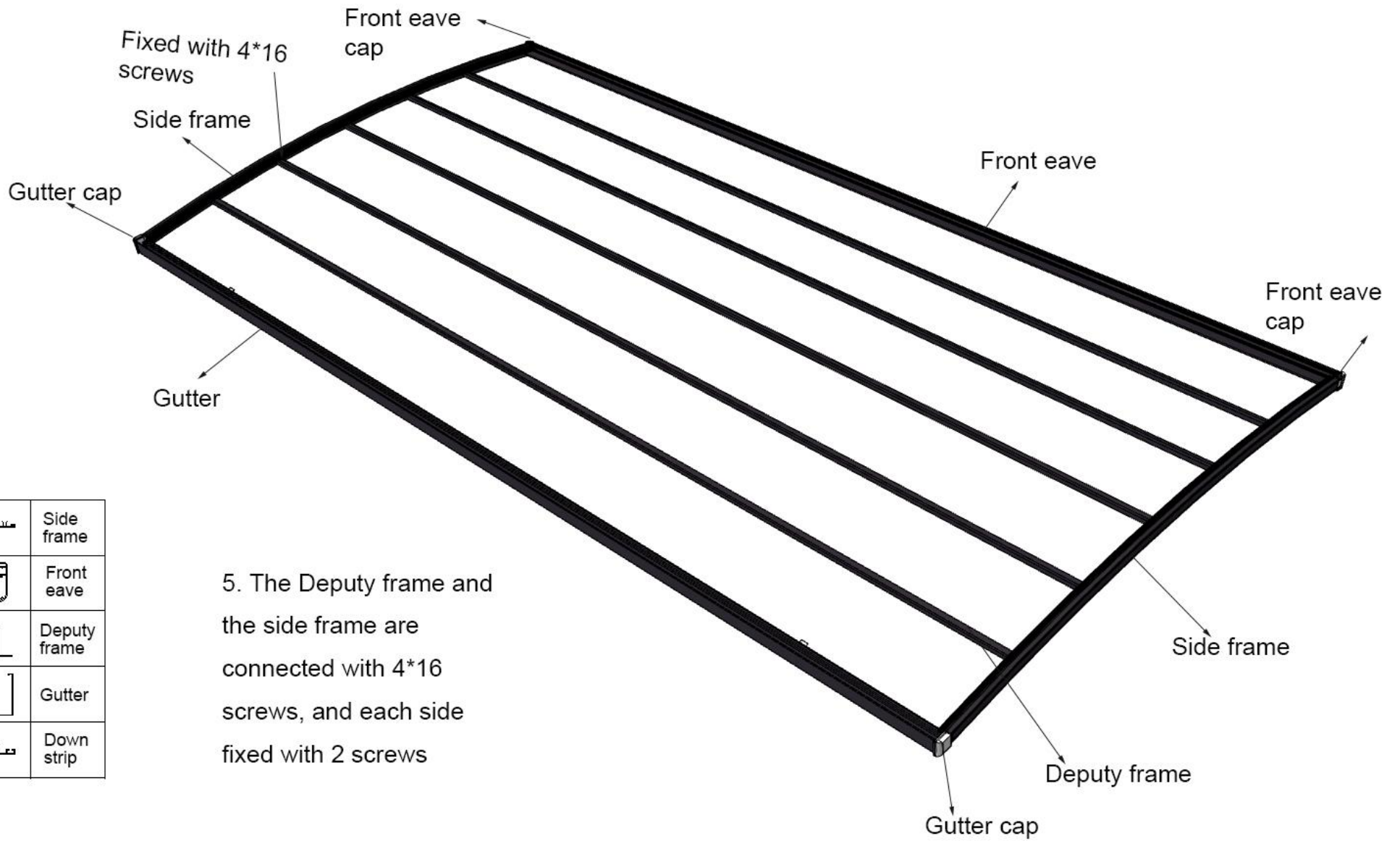







4. Connect the front eave/side frame/gutter with the gutter cap and the front eave cap, then apply neutral glass glue to make it waterproof, and use M4*16 screws to fix the caps



	Side frame
	Front eave
	Deputy frame
	Gutter
	Down strip

5. The Deputy frame and the side frame are connected with 4*16 screws, and each side fixed with 2 screws

	Side frame
	Front eave
	Deputy frame
	Gutter
	Down strip

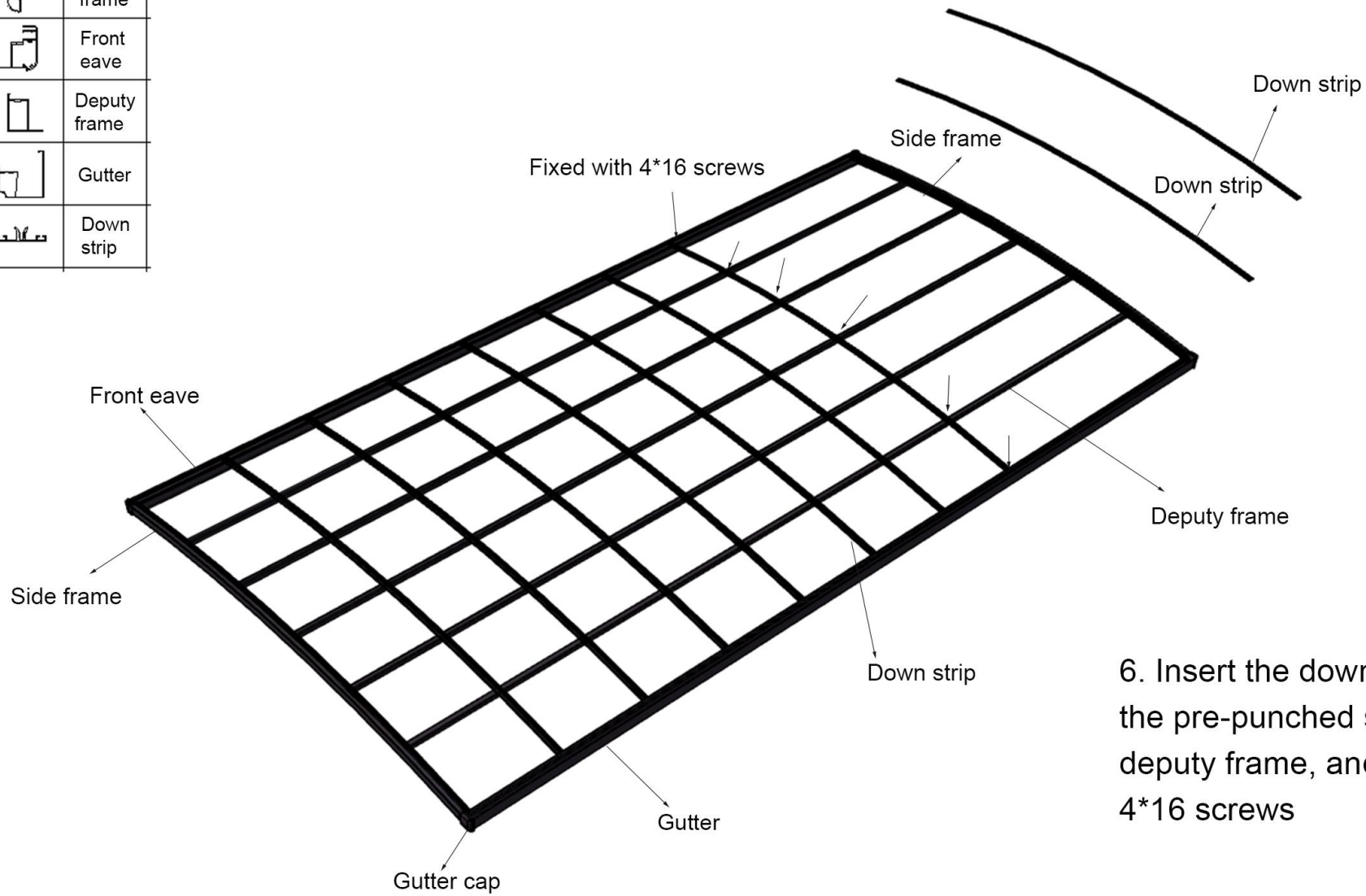

6. Insert the down strip into the pre-punched slots of the deputy frame, and fix with 4*16 screws

Use 4*16 screws to fix the deputy frame on the main beam

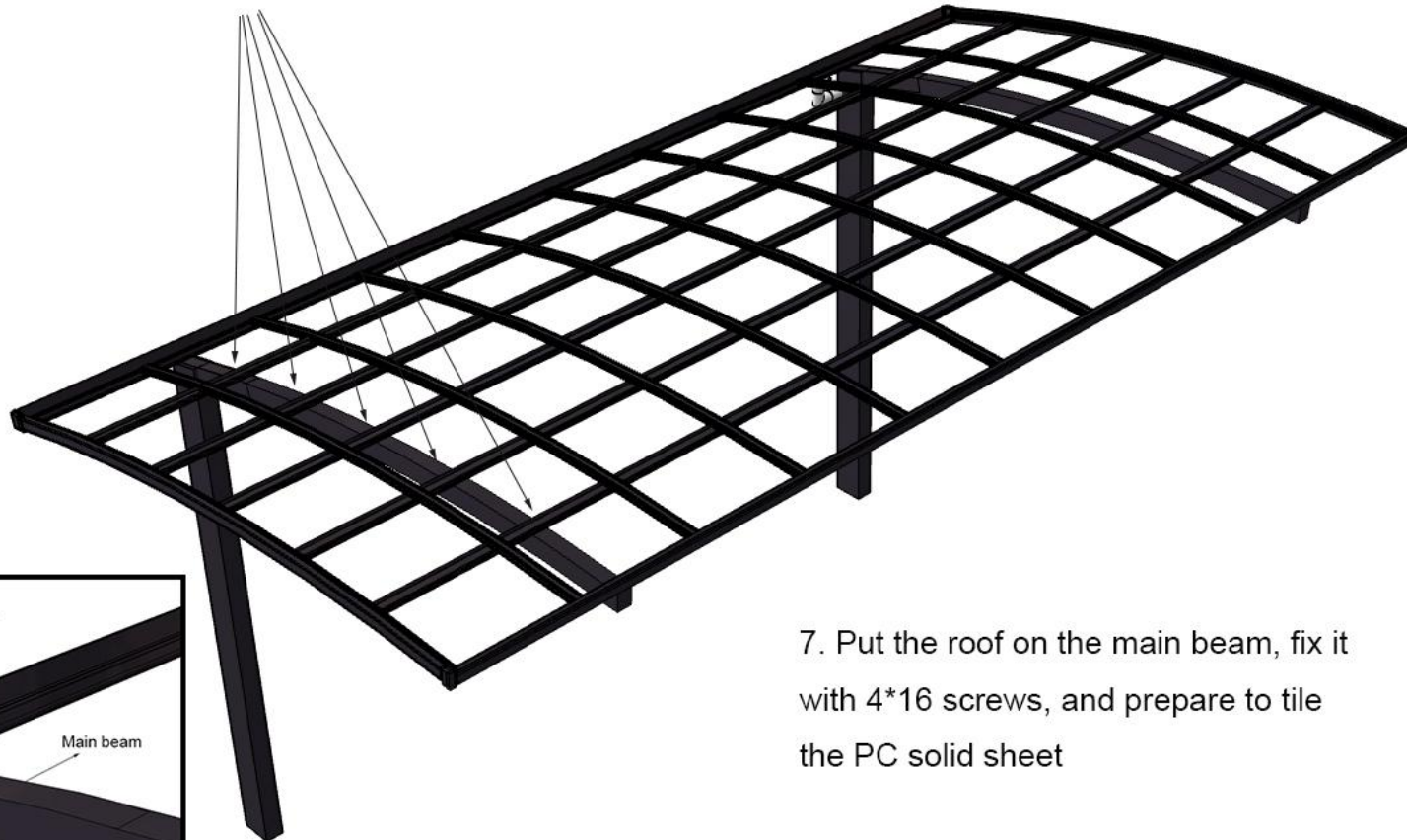

7. Put the roof on the main beam, fix it with 4*16 screws, and prepare to tile the PC solid sheet

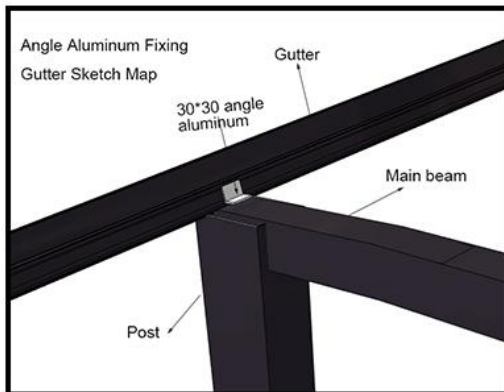

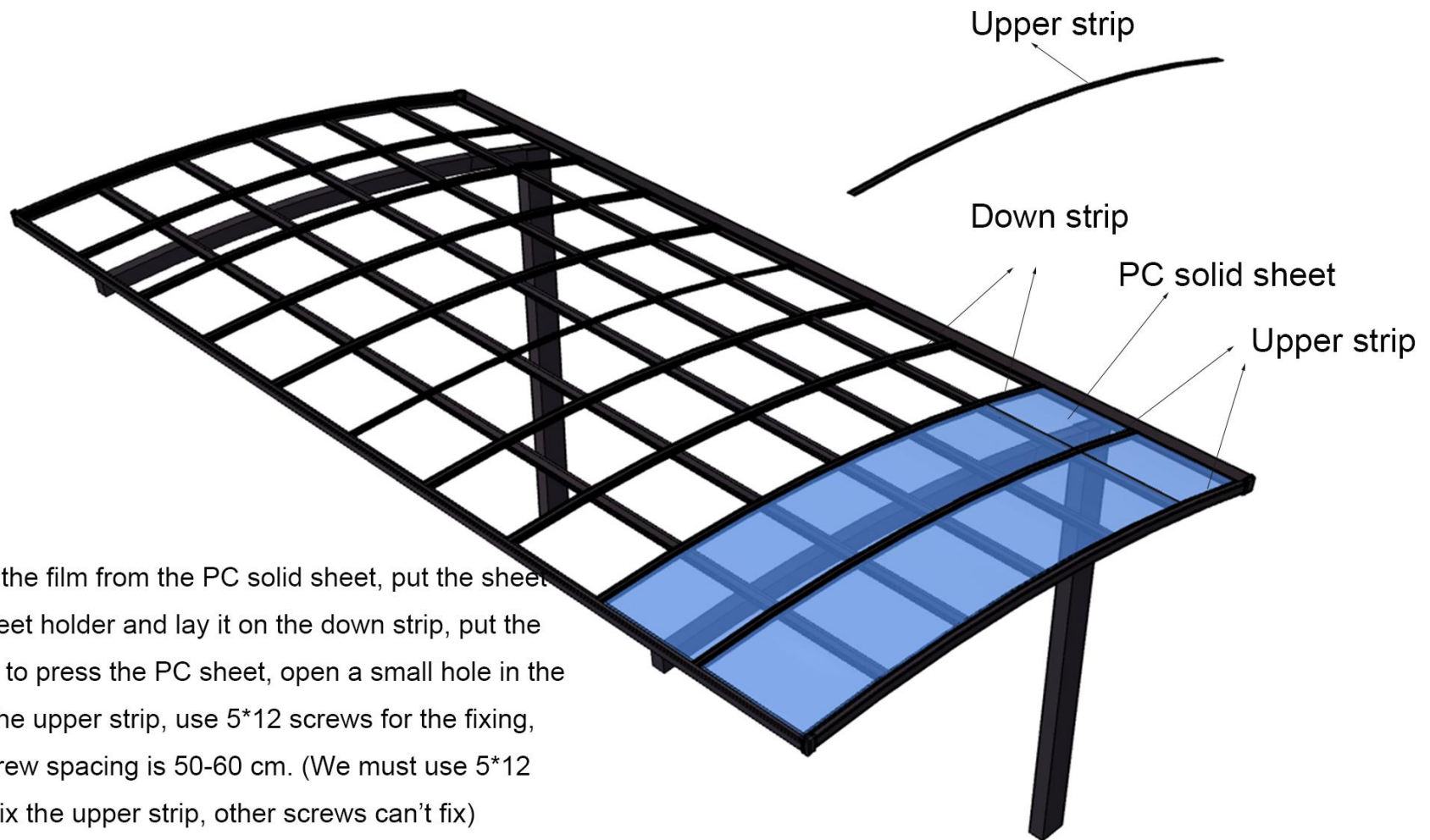

8. Tear off the film from the PC solid sheet, put the sheet into the sheet holder and lay it on the down strip, put the upper strip to press the PC sheet, open a small hole in the middle of the upper strip, use 5*12 screws for the fixing, and the screw spacing is 50-60 cm. (We must use 5*12 screws to fix the upper strip, other screws can't fix)

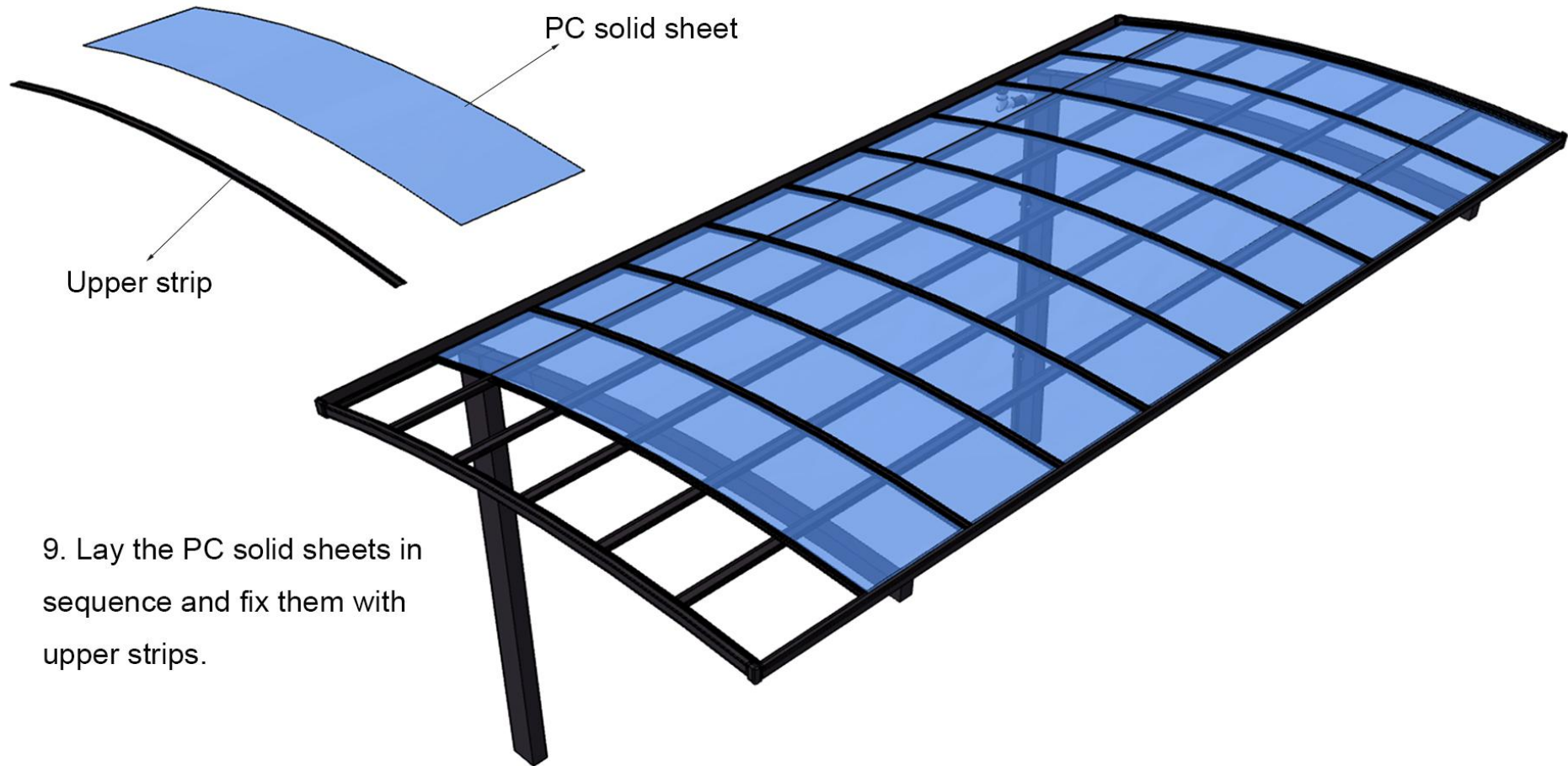

9. Lay the PC solid sheets in sequence and fix them with upper strips.

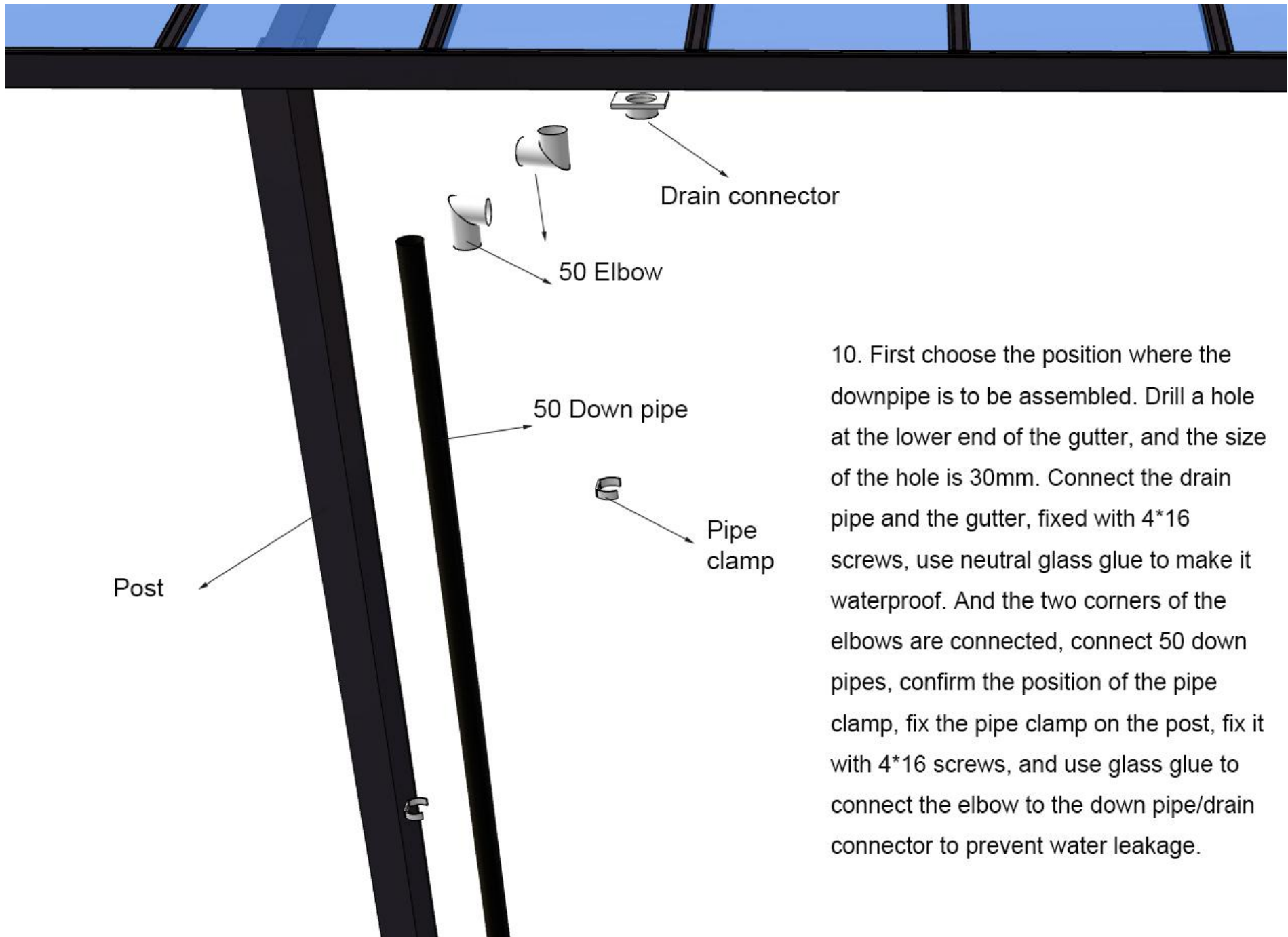

10. First choose the position where the downpipe is to be assembled. Drill a hole at the lower end of the gutter, and the size of the hole is 30mm. Connect the drain pipe and the gutter, fixed with 4*16 screws, use neutral glass glue to make it waterproof. And the two corners of the elbows are connected, connect 50 down pipes, confirm the position of the pipe clamp, fix the pipe clamp on the post, fix it with 4*16 screws, and use glass glue to connect the elbow to the down pipe/drain connector to prevent water leakage.

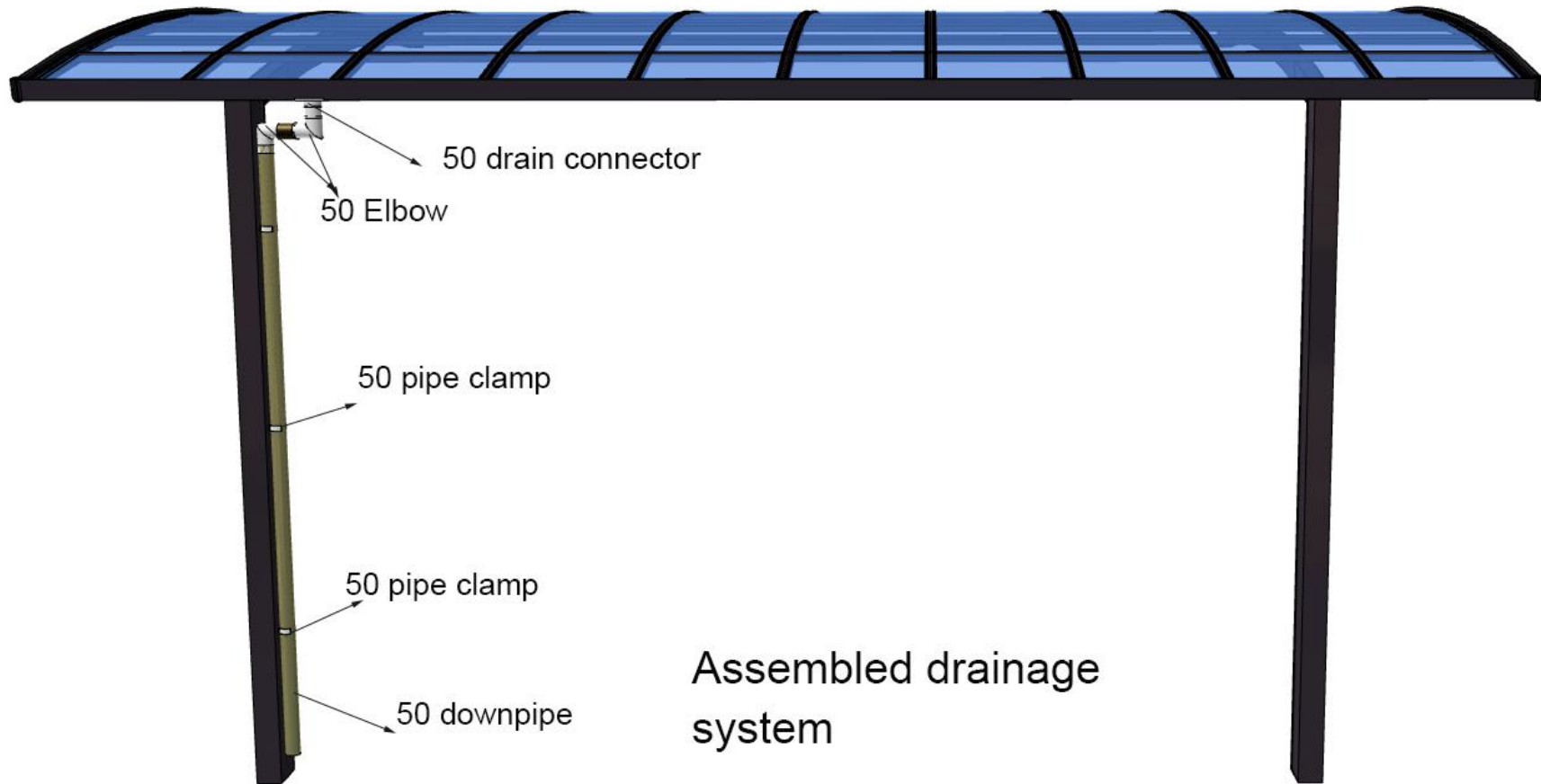



After assembly

Installation Methods:

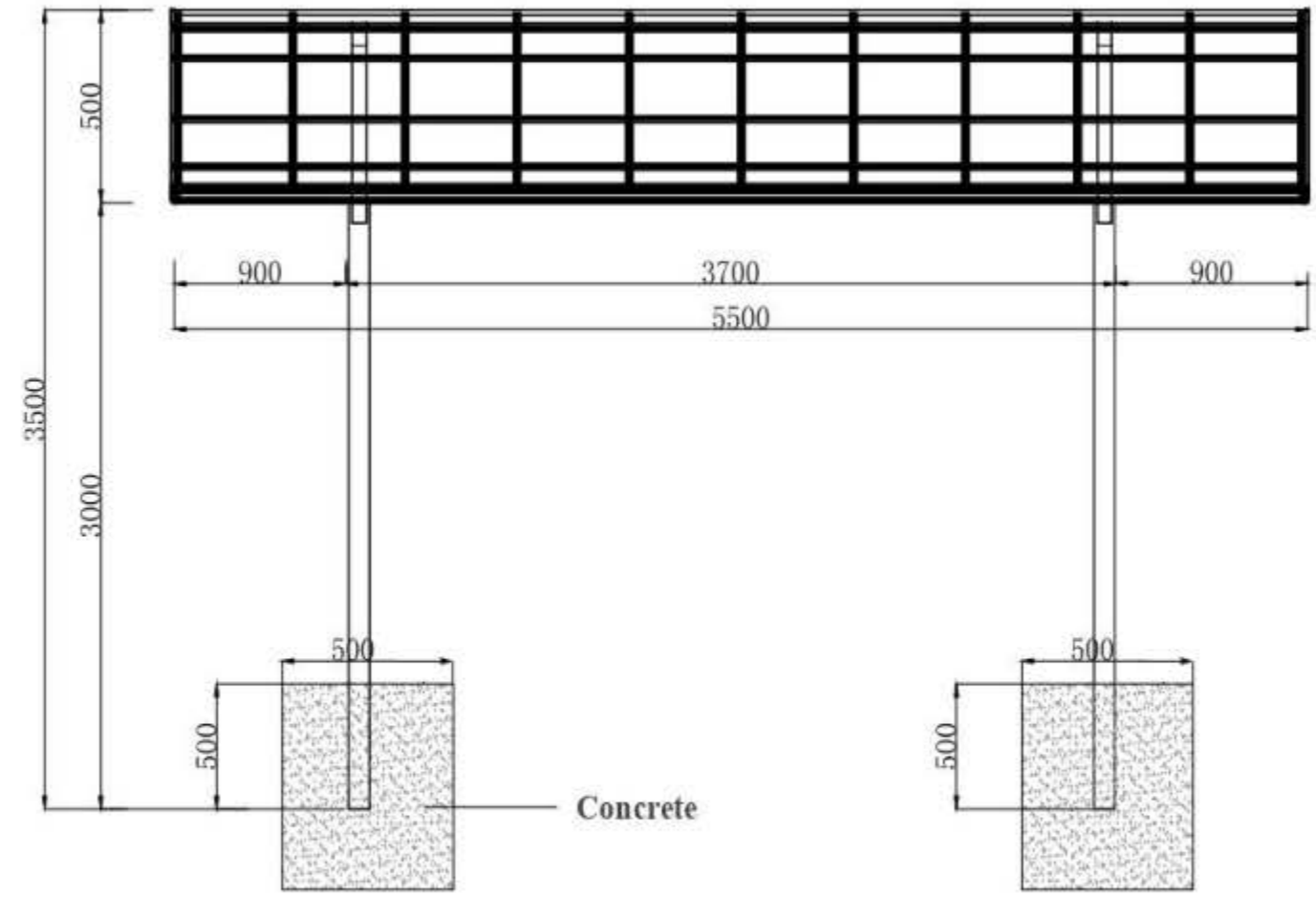

Em-buried type

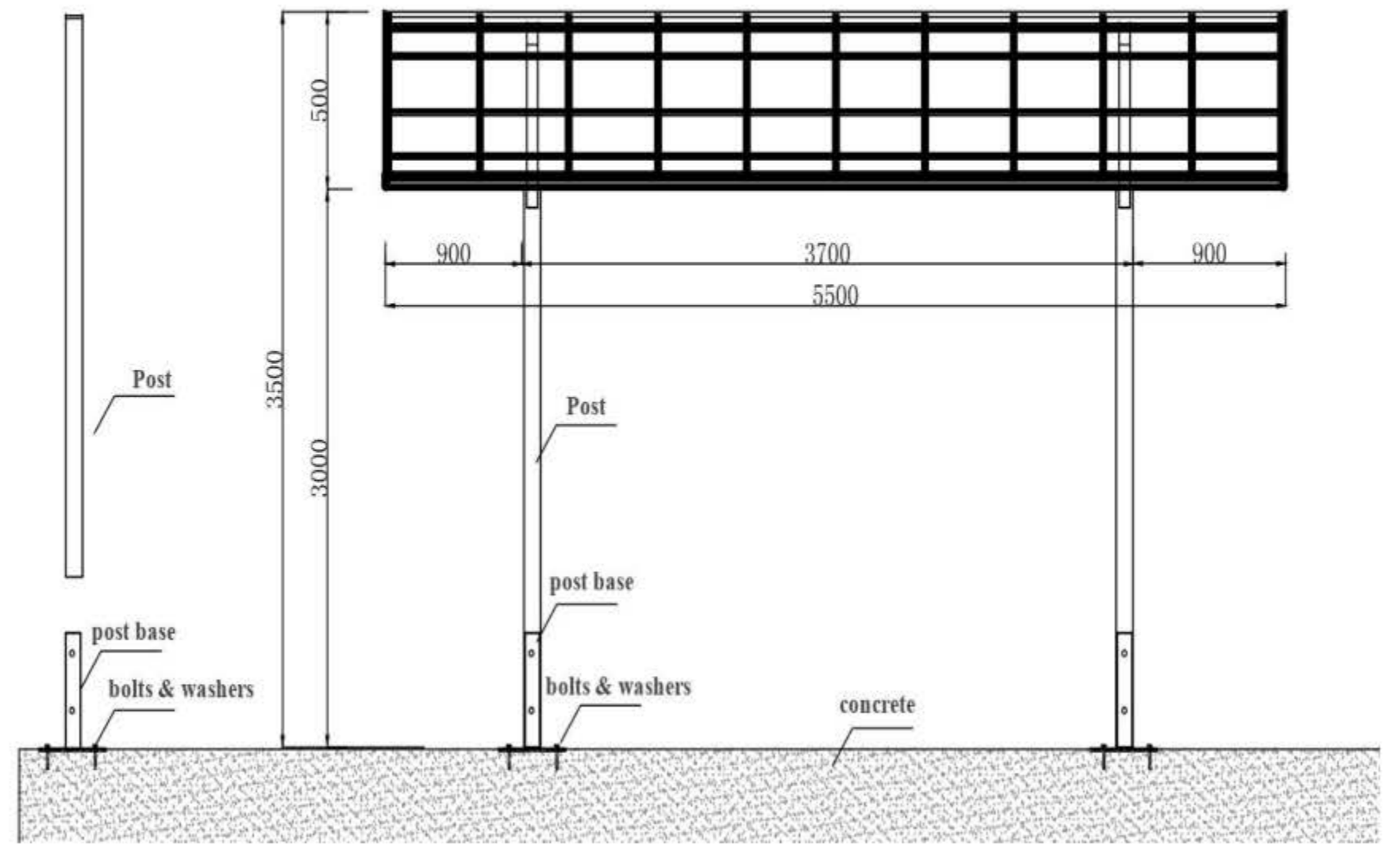

Post base type