

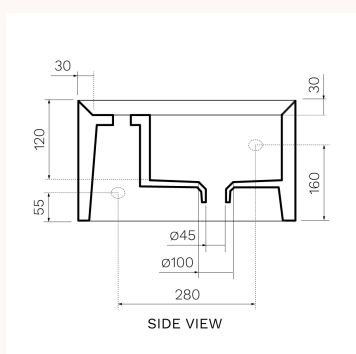

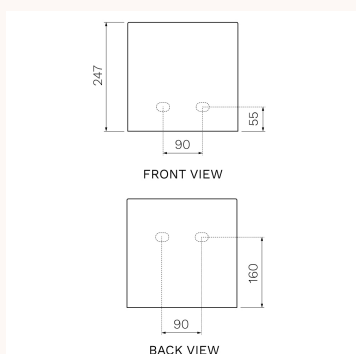

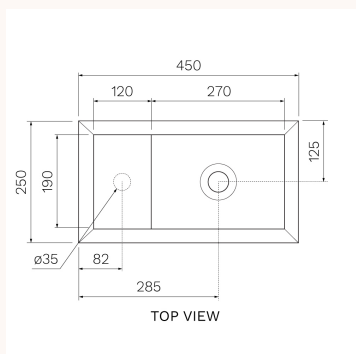

























Cut Bench Basin (45x25x25H)

VA250, VA250.01, VA250.02, VA250.22, VA250.91, VA250.92, VA250.93, VA250.94, VA250.96, VA251, VA251.01, VA251.02, VA251.22, VA251.91, VA251.92, VA251.93, VA251.94, VA251.96

The Cut Bench Basin Collection provides generous depth and sharp, square edges. Cut also offers the concept of reduction inspired by nature, with new colours enriching the effect.



Product type	Basins									
Brand	Valdama									
Collection	Cut									
Designers	Prospero Rasulo									
WxDxH	450mm x 250mm x 250mm									
Colour / Finish	<table border="0"> <tr> <td> Gloss White</td> <td> Matt White</td> <td> Gloss Black</td> </tr> <tr> <td> Matt Black</td> <td> Matt Nuvola (VA)</td> <td> Matt Tempesta</td> </tr> <tr> <td> Matt Laguna</td> <td> Matt Basento</td> <td> Matt Oceano</td> </tr> </table>	 Gloss White	 Matt White	 Gloss Black	 Matt Black	 Matt Nuvola (VA)	 Matt Tempesta	 Matt Laguna	 Matt Basento	 Matt Oceano
 Gloss White	 Matt White	 Gloss Black								
 Matt Black	 Matt Nuvola (VA)	 Matt Tempesta								
 Matt Laguna	 Matt Basento	 Matt Oceano								
Material	Ceramic									
Tap Hole Options	No Tap Hole 1 Tap Hole									
Capacity	5.5 Litres									
Overflow	No Overflow									
Waste Outlet	32mm 40mm Valdama Clic-Clac Universal Waste with Ceramic Top (VA3240) or 32mm 40mm Constant Flow Waste with Ceramic Top (VA3253) to be ordered separately									
Origin	Made In Italy									
Warranty	10 Year Warranty									
Availability	Gloss White Matt White Stocked Item Colours Pre-order 18 Weeks									
Fixing Types	Bench									
Installation Instructions:	It is recommended that the basin be installed using a flexible sealant. Epoxy type glues must not be used. To do so may void product warranty.									

