

Panasonic[®]

Operating Instructions

Microwave Oven

Household Use Only

Model No. **NN-ST25JW**
NN-ST25JB
NN-ST25JM



NN-ST25JW

We are glad you have chosen to purchase a PANASONIC microwave oven. Before operating this oven, please read these instructions carefully and completely, and keep them for further reference.

If you have never used a microwave oven before, you will realise that a microwave oven uses a totally different method of converting energy into heat. This requires an understanding of what exactly happens to food when placed in the oven. This is explained in the following pages.

After reading the introductory chapter, I am sure you will be able to master the basic technique and thereby develop a firm understanding of your new oven.

Start experimenting now, and enjoy the first class results you will achieve by using your new microwave oven.

Panasonic Australia Pty Ltd
1 Innovation Road
Macquarie Park
NSW 2113



PANASONIC NZ LTD
CUSTOMER CARE CENTRE
18 Sir Woolf Fisher Drive
Highbrook, Auckland 2013
Private Bag 14911
Panmure, Auckland

Phone: (09) 272-0178

Fax: (09) 272-0134

Email: customerservice@nz.panasonic.com

Website: www.panasonic.co.nz/support

The serial number of this product may be found on the identification label. You should note the model number and serial number of this oven in the space provided and retain this book as a permanent record of your purchase for future reference.

MODEL NUMBER _____

SERIAL NUMBER _____

DATE OF PURCHASE _____

Contents

Important safety instructions.....	2
General guidelines.....	7
Containers to use	9
Parts of your oven	11
Control panel	12
Setting the clock	13
Child safety lock	13
Microwave cooking and defrosting	14
Multi-stage cooking.....	15
Quick 30 feature	16
Using the timer	17
Auto programmes.....	19
Auto defrost	19
Auto reheat/auto cook.....	21
Defrosting charts	23
Reheating charts	24
Cooking charts.....	26
Recipes.....	30
Cooking and reheating guidelines	41
Questions and answers	42
Care of your oven	43
Specifications	44
Panasonic Warranty (Australia).....	46
Panasonic Warranty (New Zealand).....	48

Thank you for purchasing a Panasonic appliance.

Important Safety Instructions:

Before operating this oven, please read these instructions and precautions carefully and keep for future reference.

Important safety instructions

WARNING

1. The door seals and seal areas should be cleaned with a damp cloth.
The appliance should be inspected for damage to the door seals and door seal areas and if these areas are damaged the appliance should not be operated until it has been repaired by a service technician trained by the manufacturer.
2. Liquids and other foods must not be heated in sealed containers since they are liable to explode.
3. **WHEN YOUR OVEN REQUIRES SERVICING**, call your local Panasonic engineer (Customer Support). It is hazardous for anyone other than a competent person to carry out any service or repair operation which involves the removal of a cover which gives protection against exposure to microwave energy.

CAUTION

1. Do not attempt to tamper with or make any adjustments or repairs to the door, control panel housing, safety interlock switches or any other part of the oven. Do not remove the outer panel from the oven which gives protection against exposure to microwave energy. Repairs should only be done by a qualified service person.

2. Do not operate this appliance if it has a damaged CORD OR PLUG, if it is not working properly, or if it has been damaged or dropped. It is dangerous for anyone other than a service technician trained by the manufacturer to perform repair service.
3. If the supply cord is damaged, it must be replaced by the manufacturer, its service agent or similarly qualified person in order to avoid a hazard.
4. This appliance is not intended for use by persons (including children) with reduced physical, sensory or mental capabilities, or lack of experience and knowledge unless they have been given supervision or instruction concerning use of the appliance by a person responsible for their safety. Children should be supervised to ensure that they do not play with the appliance.
5. The microwave oven is intended for heating food and beverages. Drying of food, newspaper or clothing and heating of warming pads, slippers, sponges, damp cloth and similar may lead to risk of injury, ignition or fire.
6. Before use, check that utensils/containers are suitable for use in microwave ovens.
7. The oven will only operate with the door closed.
8. When the oven is not being used, do not store any objects other than oven accessories inside the oven in case it is accidentally turned on.

9. The appliance shall not be operated WITHOUT FOOD IN THE OVEN.

Operation in this manner may damage the appliance.

10. If smoke or a fire occurs in the oven, press Stop/Reset, and leave the door closed in order to stifle any flames.
Disconnect the power cord, or shut off the power at the fuse or the circuit breaker panel.

11. The oven lamp must be replaced by a service technician trained by the manufacturer. Do not attempt to remove the outer casing from the oven.

Installation

Examine your microwave oven

Unpack the oven, remove all packing material, and examine the oven for any damage such as dents, broken door latches or cracks in the door. If you find any damage, notify your dealer immediately. Do not install a damaged microwave oven.

Earthing instructions

IMPORTANT: THIS UNIT HAS TO BE PROPERLY EARTHED FOR PERSONAL SAFETY.

If your AC outlet is not earthed, it is the personal responsibility of the customer to have it replaced with a properly earthed wall socket.

Operation voltage

The voltage has to be the same as specified on the label on the oven. If a higher voltage than specified is used, it may cause a fire or other damages.

WE CERTIFY THAT THIS MICROWAVE OVEN HAS BEEN INSPECTED AND COMPLIES WITH THE REQUIREMENTS OF REGULATION 3, SUBCLAUSE(2), OF THE MICROWAVE OVENS REGULATIONS 1982.

(This statement applicable only to New Zealand.)

Placement of the oven

This appliance is intended to be used in household and similar applications such as:

- staff kitchen areas in shops, offices and other working environments;
- farm houses;
- by clients in hotels, motels and other residential environments;
- bed and breakfast type environments.

1. Place the oven on a flat and stable surface, more than 85 cm above the floor.
The appliance is freestanding type and shall not be placed in a cabinet.

2. When this oven is installed, it should be easy to isolate the appliance from the electricity supply by pulling out the plug or operating a circuit breaker.

Important safety instructions

3. For proper operation, ensure a sufficient air circulation for the oven.

Counter-top use:

Allow 15 cm of space on the top of the oven, 10 cm at the back and on 5 cm both sides.

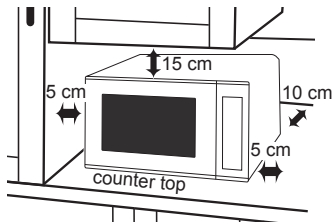

If one side of the oven is placed flush to a wall, the other side or top must not be blocked.

4. Do not place this oven near an electric or gas cooker range.
5. The feet should not be removed.
6. This oven is only for household usage. Do not use outdoors.
7. Avoid using the microwave oven in high humidity.
8. The power cord should not touch the outside of the oven. Keep the cord away from hot surfaces. Do not let the cord hang over the edge of a table or work top. Do not immerse the cord, plug or oven in water.
9. Do not block the air vents on the left side and back of the oven. If these openings are blocked during operation the oven may overheat. In this case the oven is protected by a thermal safety device and resumes operation only after cooling down.
10. When it becomes necessary to replace the oven light, please consult your dealer.

Accessories

The oven comes equipped with a variety of accessories. Always follow the directions given for use of the accessories.

Roller ring

- The roller ring and the oven floor should be cleaned frequently to prevent noise and build-up of remaining food.
- The roller ring must always be used for cooking together with the glass tray.

Glass tray

- Always operate the oven with the roller ring and glass tray in place.
- Only use the glass tray specifically designed for this oven. Do not substitute with any other glass tray.
- If the glass tray is hot, let it cool before cleaning or placing in water.
- The glass tray can turn in either direction.
- If the food or cooking vessel on the glass tray touches the oven walls and stops the tray rotating, the tray will automatically rotate in the opposite direction. This is normal. Open oven door, reposition the food and restart.
- Do not cook foods directly on the glass tray unless indicated in recipes. Always place food in a microwave safe dish.
- While cooking, the glass tray may vibrate. This will not affect cooking performance.

Important

If the recommended cooking time is exceeded, the food will be spoiled and in extreme circumstances could catch fire and possibly damage the interior of the oven.

Short cooking time

As microwave cooking time is much shorter than other cooking methods, it is essential that recommended cooking time is not exceeded without first checking the food.

Factors that may affect cooking time are: preferred degree of cooking, starting temperature, altitude, volume, size and shape of foods and utensils used. As you become familiar with the oven, you will be able to adjust these factors.

It is better to undercook rather than overcook foods. If food is undercooked, it can always be returned to the oven for further cooking. If food is overcooked, nothing can be done. Always start with minimum cooking time.

Small quantities of food

Take care when heating small quantities of food as these can easily burn, dry out or catch fire if cooked too long. Always set short cooking time and check the food frequently.

Foods low in moisture

Take care when heating foods low in moisture, e.g. bread items, chocolate, popcorn, biscuits and pastries. These can easily burn, dry out or catch on fire if cooked too long. We do not recommend heating foods low in moisture such as popcorn or bread.

This oven has been developed for food use only.

We do not recommend to use for heating non food items such as wheat bags or hot water bottles.

Reheating

It is essential that reheated food is served “piping hot”.

Remove the food from the oven and check that it is “piping hot”, i.e. steam is being emitted from all parts and all sauce is bubbling. (You may choose to check the food has reached 72 °C with a food thermometer – but remember do not use this thermometer inside the microwave.)

For foods that cannot be stirred, e.g. lasagne, shepherds pie, the centre should be cut with a knife to test it is well heated through. Even if a manufacturer’s packet instructions have been followed always check the food is piping hot before serving and if in doubt return your food to the oven for further heating.

Standing time

Standing time refers to the period at the end of cooking or reheating when food is left before being eaten, i.e. it is a rest time which allows the heat in the food to continue to conduct to the centre, thus eliminating cold spots.

Important safety instructions

Lids

Always remove the lids of jars and containers and takeaway food containers before you microwave the food. If the lid remains, then steam and pressure might build up inside and cause an explosion even after the microwave cooking has stopped.

Babies bottles and food jars

When reheating babies bottles always remove top and teat. Liquid at the top of the bottle will be much hotter than that at the bottom and must be shaken thoroughly before checking the temperature. This should be carried out before consumption to avoid burns. See page 41.

Boiled eggs

Eggs in their shell and whole hard-boiled eggs should not be heated in microwave ovens since they may explode even after microwave heating has ended.

Foods with skins

Potatoes, apples, egg yolk, whole vegetables and sausages are examples of food with non porous skins. These must be pierced using a fork before cooking to prevent bursting.

Paper and plastic

When heating food in plastic or paper containers, keep an eye on the oven due to the possibility of ignition. Do not use wire twist-ties with roasting bags as arcing will occur.

Do not use re-cycled paper products, e.g. Kitchen roll unless they say they are specifically designed for use in a microwave oven. These products contain impurities which may cause sparks and/or fires when used.

Liquids

Microwave heating of beverages can result in delayed eruptive boiling, therefore care should be taken when handling the container. To prevent the possibility of sudden boil the following steps should be taken:

- a) Avoid using straight-sided containers with narrow necks.
- b) Do not overheat.
- c) Stir the liquid before placing the container in the oven and again halfway through the heating time.
- d) After heating, allow to stand in the oven for a short time, stirring again before carefully removing the container.

Deep fat frying

Do not attempt to deep fat fry in your oven.

Arcing

Arcing may occur accidentally if a metal container has been used or the incorrect weight of food is used. Arcing is flashes of blue light seen in the microwave oven. If this occurs, stop the machine immediately. If the oven is left unattended and this continues it can damage the machine.

Meat thermometer

Use a meat thermometer to check the degree of cooking of joints and poultry only when meat has been removed from the microwave. If undercooked, return to the oven and cook for a few more minutes at the recommended power level. Do not leave a conventional meat thermometer in the oven when microwaving.

General guidelines

CLEANING

As microwaves work on food particles, keep your oven clean at all times. Stubborn spots of food can be removed by using a microwave spray cleaner, sprayed onto a soft cloth. Always wipe the oven dry after cleaning.

Refer to “Care of your oven” on page 43 for details on cleaning.

The warranty only applies if the product has been used in accordance with the operating instructions under normal use and reasonable care.

STANDING TIME

Dense foods e.g. meat, jacket potatoes and cakes, require standing time (inside or outside of the oven) after cooking, to allow heat to finish conducting to the centre of the food to cook through completely. Wrap meat joints and jacket potatoes in aluminium foil while standing. Meat joints need approx. 10–15 minutes, jacket potatoes 5 minutes. Other foods such as plated meals, vegetables, fish etc. require 2–5 minutes standing. If food is not cooked after standing time, return to the oven and cook for additional time. After defrosting food, standing time should also be allowed.

QUANTITY



Small quantities cook faster than large quantities, and small meals will reheat more quickly than large portions.

SPACING



Foods cook more quickly and evenly if spaced apart. NEVER pile foods on top of each other.

PIERCING



The skin or membrane on some foods will cause steam to build up during cooking.

These foods must be pierced or a strip of skin should be peeled off before cooking to allow the steam to escape. Eggs, potatoes, apples, sausages etc, will all need to be pierced before cooking. DO NOT ATTEMPT TO BOIL EGGS IN THEIR SHELLS.

COVERING



Cover foods with microwave cling film or a lid. Cover fish, vegetables, casseroles, soups. Do not cover cakes, sauces, jacket potatoes or pastry items.

General guidelines

MOISTURE CONTENT

Many fresh foods e.g. vegetables and fruit, vary in their moisture content throughout the season. For this reason cooking time may have to be adjusted. Dry ingredients e.g. rice, pasta, can dry out during storage so cooking time may differ.

DENSITY

Porous airy foods heat more quickly than dense heavy foods.

SHAPE



Even shapes cook evenly. Food cooks better by microwave when in a round container rather than square.

STARTING TEMPERATURE

The colder the food, the longer it takes to heat up. Food from a fridge takes longer to reheat than food at room temperature. Food temperature should be between 5 and 8 °C before cooking.

LIQUIDS



All liquids must be **STIRRED BEFORE, DURING AND AFTER** heating. Water must be stirred before and during heating, to avoid eruption. Do not heat liquids that have previously been boiled. **DO NOT OVERHEAT.**

TURNING AND STIRRING

Some foods require stirring during cooking. Meat and poultry should be turned after half of the cooking time.

ARRANGING

Individual foods e.g. chicken portions or chops, should be placed on a dish so that the thicker parts are towards the outside.

CHECKING FOOD



It is essential that food is checked during and after a recommended cooking time, even if an **AUTO PROGRAMME** has been used (just as you would check food cooked in a conventional oven). Return the food to the oven for further cooking if necessary.

DISH SIZE



Follow the dish sizes given in the recipes, as these affect the cooking and reheating times.

A quantity of food spread in a bigger dish cooks and reheats faster.

CLING FILM

Cling film helps keep the food moist and the trapped steam assists in speeding up cooking time. Pierce before cooking to allow excess steam to escape. Always take care when removing cling film from a dish as the build-up of steam will be very hot.

Containers to use

Choosing the correct container is a very important factor in deciding the success or failure of your cooking.

OVEN GLASS

Glass that is heat resistant e.g. Pyrex®, is ideal, and can be used.

Do not use glass which may crack due to the heat from the food. Do not use lead crystal which may crack or arc.



CHINA AND CERAMIC

Glazed china plates, saucers, bowls, mugs and cups can be used if they are heat resistant.

Porcelain and ceramic are also ideal. Fine bone china should only be used for reheating for short period of time, otherwise the change in temperature may crack the dish or craze the finish. Do not use dishes with a metal rim or pattern. Do not use jugs or mugs with glued handles, since the glue can melt in a microwave.



POTTERY, EARTHENWARE, STONEWARE

Only use if completely glazed. Do not use if partially glazed or unglazed, as they are able to absorb water which will absorb microwave energy, making the container very hot and slowing down the cooking of food.



FOIL/METAL CONTAINERS

NEVER ATTEMPT TO COOK IN FOIL OR METAL containers – the microwaves cannot pass through and the food will not heat evenly – this may also damage your oven. Use wooden kebab sticks instead of metal skewers.



CLING FILM

Use microwave cling film to cover food that is to be reheated, or cooked, ON MICROWAVE ONLY taking care to avoid the film being in direct contact with the food.



Containers to use

PLASTIC

Many plastic containers are designed for microwave use. Only use containers if they are designed for microwave use. Do not use Melamine as it will scorch. Do not use plastic for cooking foods high in sugar or fat or foods that require long cooking time e.g. brown rice. Never cook in margarine containers or yogurt pots, as these will melt with the heat from the food.



PAPER

Plain white kitchen paper (kitchen towel) can be used for covering blind pastry cases and for covering bacon to prevent splattering **ONLY USE FOR SHORT COOKING TIME. NEVER RE-USE A PIECE OF KITCHEN TOWEL.** Avoid kitchen paper containing manmade fibers. Check that branded re-cycled kitchen towel is recommended for microwave use. Do not use waxed or plastic coated cups as the finish may melt in the oven. Greaseproof paper can be used to line the base of dishes and to cover fatty foods. White paper plates can be used for **SHORT REHEATING TIMES, ON MICROWAVE ONLY.**



WICKER, WOOD, STRAW BASKETS

Do not use these items in your microwave. With continued use and with prolonged exposure they will crack and could ignite.



ALUMINIUM FOIL

Small amounts of smooth aluminium foil can be used to **SHIELD** joints of meat during defrosting. As the microwaves cannot pass through the foil this prevents the shielded parts from overcooking or overdefrosting. The foil must not touch the sides or roof of the oven, as this may cause arcing and damage your oven.



ROASTING BAGS

These are useful when slit up one side to tent a joint of meat when roasting by power and time. **DO NOT USE THE METAL TWISTS SUPPLIED.**

Parts of your oven

1. Door release button

Press to open the door. Opening the door during cooking will stop the cooking process without cancelling the programme. It is quite safe to open the door at any time during a cooking programme and there is no risk of microwave exposure. Cooking resumes after the door is closed and Start is pressed.

2. Oven window

3. Air vents

4. Microwave feed guide (Do not remove.)

5. External air vents

6. Control panel

7. Power supply cord

8. Plug

9. Glass tray

10. Roller ring

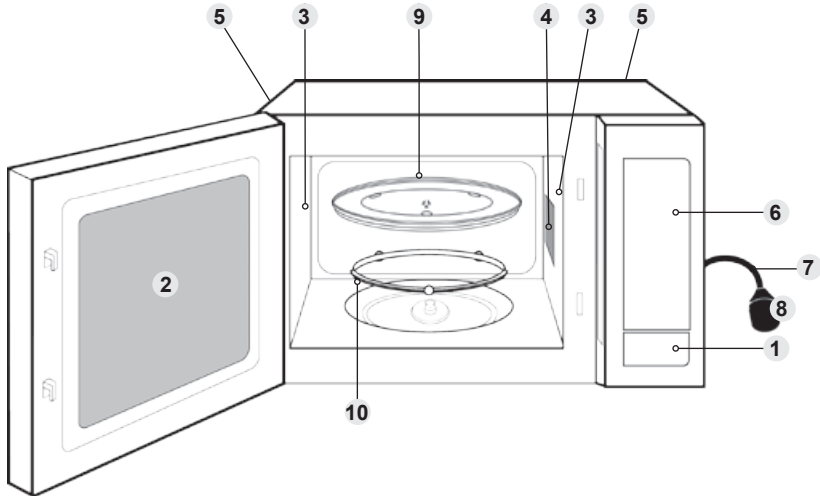

Identification label is attached on the oven.

■ Note

This illustration is for reference only.

Control panel

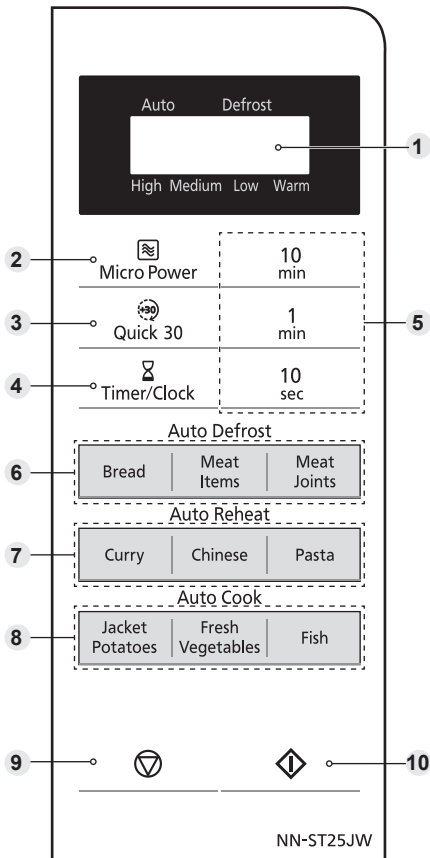

- 1 Display window
- 2 Micro Power pad
- 3 Quick 30 pad
- 4 Timer / Clock pad
- 5 Time pads
- 6 Auto Defrost pads
- 7 Auto Reheat pads
- 8 Auto Cook pads
- 9 Stop / Reset pad:

Before Cooking:

One press clears your instructions.

During Cooking:

One press temporarily stops the cooking process. Another press cancels all your instructions and a colon or the time of day will appear in the display.

10 Start pad

One press allows oven to begin functioning. If door is opened or Stop/Reset is pressed once during oven operation, Start must be pressed again to restart oven.

- Your control panel may have differences in appearance, but the words on the pads and functionality will be the same.

■ Beep sound

When a pad is pressed correctly a beep will be heard. If a pad is pressed and no beep is heard, the unit has not or cannot accept the instruction. The oven will beep twice between programmed stages. At the end of any complete programme, the oven will beep 5 times and "End" will be displayed.

■ Note

If Start is not pressed for 6 minutes after cooking programme setting, the oven will automatically cancel the cooking programme. The display will revert back to clock or colon.

Setting the clock

When the oven is plugged in for the first time, “88.88” appears in display.

Example: To set 11:25am

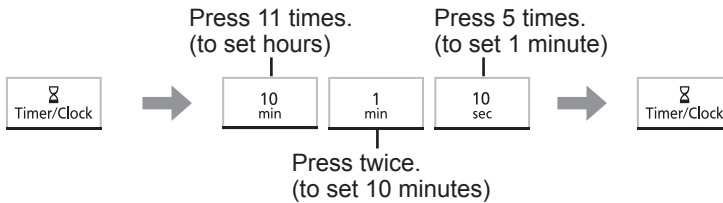

Press Timer/Clock twice.
A colon starts to blink.

Enter time of day.

Press Timer/Clock.
The colon stops blinking. Time of day is now locked into the display.

■ Notes

1. To reset the clock, repeat step 1 through to step 3, as above.
2. The clock will keep the time of day as long as the oven is plugged in and electricity is supplied.
3. This is a 12 hour clock.

Child safety lock

This feature will make the oven controls inoperable; however, the door can be opened. Child Lock can be set when the display shows a colon or the time.

To Set:



Press Start 3 times in 10 seconds.
The clock will disappear. Actual time will not be lost. “Child” is indicated in the display.

To Cancel:



Press Stop/Reset 3 times in 10 seconds.
The clock will reappear in the display.

Microwave cooking and defrosting

The glass tray must always be in position when using the oven.



Press Micro Power to select the desired power level.

Set the cooking time.

Your oven can be programmed for up to 99 minutes 50 seconds in Medium, Low, Warm and Defrost power. High power can be programmed for up to 30 minutes.

Press Start.

The time counts down in the display.

Press	Power Level		Example of Use
once	High	800 W	Boil water. Cook fresh fruit, vegetables, rice, pasta and noodles.
twice	Defrost	270 W	Thaw foods.
3 times	Medium	700 W	Cook poultry, meat, cakes and desserts. Heat milk.
4 times	Low	520 W	Cook eggs, cheeses, fish, pot roasts, casseroles and meat loaves. Melt chocolate.
5 times	Warm	200 W	Keep cooked foods warm, simmer slowly.

■ **Notes**

1. The oven will automatically work on High microwave power if a cooking time is entered without the power level previously being selected.
2. While cooking, the glass tray may vibrate. This will not affect cooking performance.
3. For MULTI-STAGE COOKING, refer to page 15.
4. STANDING TIME can be programmed after microwave power and time setting. Refer to page 17.
5. DO NOT cook with any metal accessory in the oven.
6. Always check the food during defrosting by opening the door then restarting. It is not necessary to cover food during defrosting. To ensure an even result, stir, turn or separate several times during defrosting. For large joints and poultry, turn halfway through defrosting and protect ends and tips with foil. Refer to Defrosting guidelines on page 20 for details.

Multi-stage cooking

This feature allows you to programme up to 3 stages of cooking continuously.

Example: To continually set High power for 2 minutes, Medium power for 3 minutes and Low power for 2 minutes.

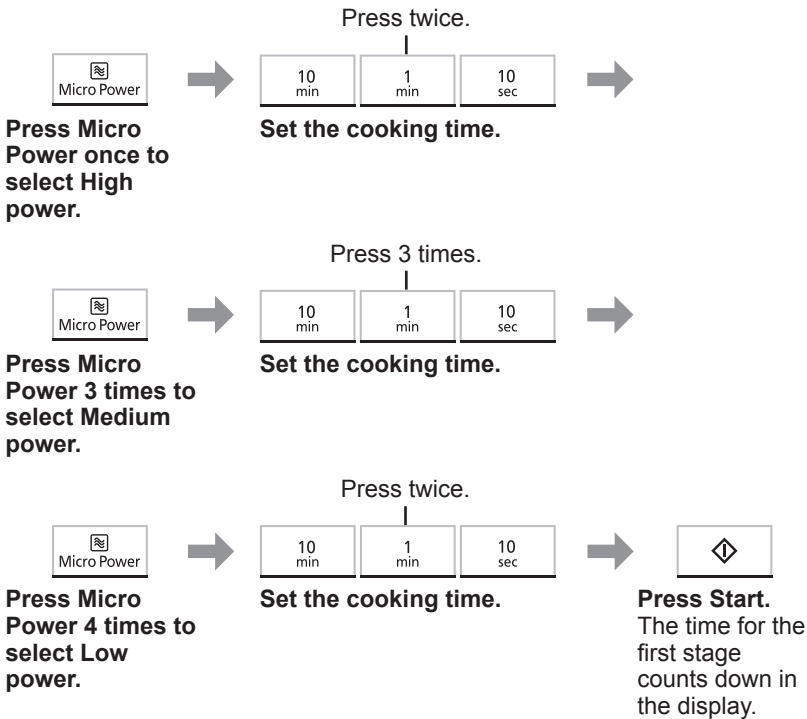

■ Notes

1. AUTO PROGRAMMES cannot be used with MULTI-STAGE COOKING.
2. When operating, 2 beeps will sound between each stage, and 5 beeps will sound after all stages have finished.

Quick 30 feature

This feature allows you to set cooking time in 30 seconds increments up to 5 minutes at High power.



Press Quick 30 until the desired cooking time appears in the display.

Press Start.
The time counts down in the display.

■ Note

If desired, you can use other power levels. Select the desired power level before pressing Quick 30.

Using the timer

This feature operates as a KITCHEN TIMER or allows you to programme the STANDING TIME/DELAY START.

Kitchen timer

Example: To count 5 minutes.

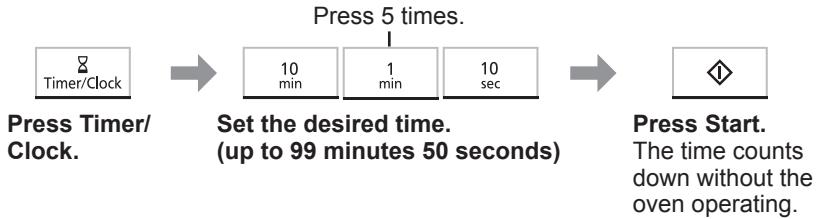

Standing time

Example: To stand for 5 minutes after cooking at Medium power for 3 minutes.

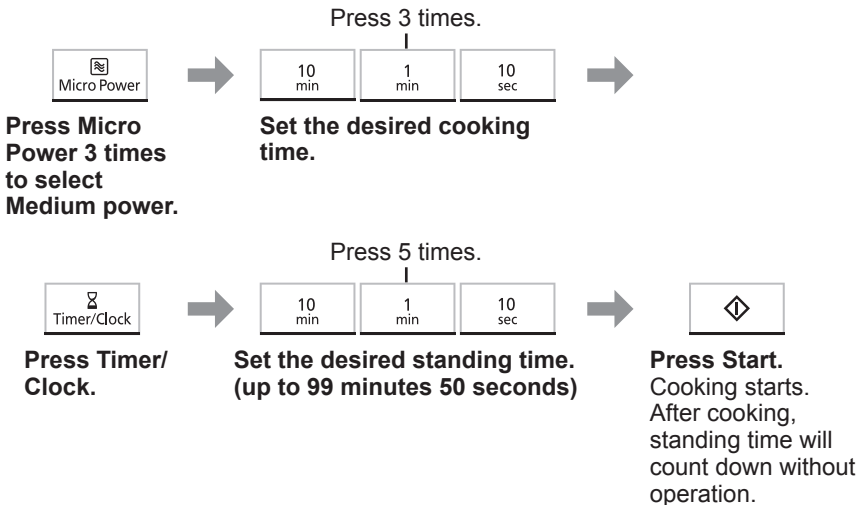

Using the timer

Delay start

Example: To start cooking at Medium power for 3 minutes after 5 minutes of standing time.

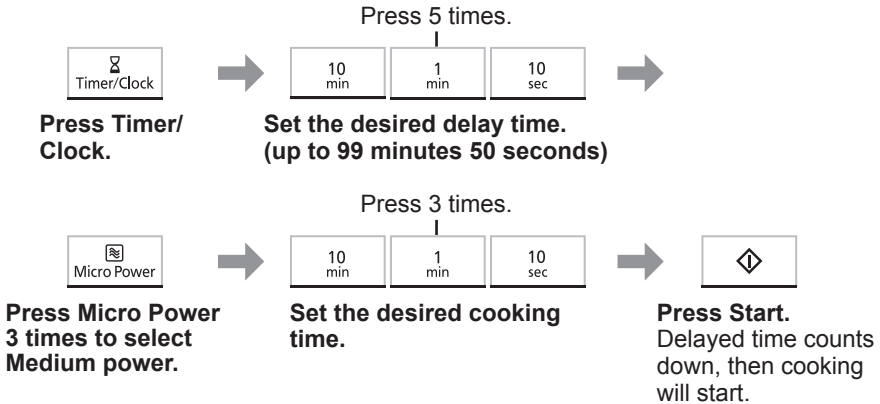

■ Notes

1. MULTI-STAGE COOKING can be programmed including STANDING TIME and DELAY START.
2. Even if the oven door is opened during KITCHEN TIMER, STANDING TIME or DELAY START, the time in the display window will continue to count down.
3. STANDING TIME/DELAY START cannot be programmed before/after any AUTO PROGRAMME.

Auto programmes

With this feature you can defrost/cook food according to the weight. Select the category and set the weight of the food. The weight is programmed in grams. The oven determines MICROWAVE power level, and then cooking time automatically. Do not include the weight of any added water or the container weight.

■ Notes

1. The AUTO PROGRAMMES must ONLY be used for foods described.
2. Only defrost/cook foods within the weight ranges described.
3. Always weigh the food rather than relying on the package information.
4. Most foods benefit from STANDING TIME. After cooking with an AUTO PROGRAMME, allow heat to continue conducting to the centre.

Auto defrost

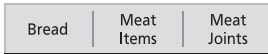





Press a desired Auto Defrost pad several times until the appropriate weight appears.

Press Start.
The time counts down in the display.

■ Note

The shape and size of the food will determine the maximum weight the oven can accommodate.

Programme	Instructions
	<p>Weight: 100-600 g Accessories: </p> <p>For small items which are required for immediate use, they may feel warm straight after defrosting. Loaves can also be defrosted on this programme but these will require standing time to allow the centre to thaw out. Standing time can be shortened if slices are separated and buns and loaves cut in half. Items should be turned halfway during defrosting. THIS PROGRAMME IS NOT SUITABLE FOR CREAM CAKES OR DESSERTS e.g. cheesecake.</p>
 (mince/chops/ chicken portions)	<p>Weight: 200-1000 g Accessories: </p> <p>NOT SUITABLE FOR SAUSAGES, which can be defrosted manually using defrost power and time. Chops and chicken portions should be arranged in a single layer and turned frequently during defrosting. It is necessary for mince to be broken up frequently during defrosting and this is best carried out in a large shallow dish.</p>

Auto programmes

Programme	Instructions
<div style="text-align: center;"> <div style="border: 1px solid black; padding: 2px; display: inline-block;">Meat Joints</div> (Whole Chickens, etc.) </div>	<p>Weight: 600-1600 g Accessories: </p> <p>Whole chickens and meat joints will require shielding during defrosting especially if it is a particularly fatty piece. This is to prevent food starting to cook on the outside edges. Protect wings, breast and fat with smooth pieces of aluminium foil secured with cocktail sticks. DO NOT ALLOW THE FOIL TO TOUCH THE WALLS OF THE OVEN. Standing time of at least 1 hour should be allowed for joints after defrosting.</p>

Defrosting guidelines

For Best Results:

1. Place foods in a suitable container. Meat joints and chickens should be placed on an upturned saucer or on a plastic rack if you have one.
2. Check food during defrosting, as foods vary in their defrosting speed.
3. It is not necessary to cover the whole food (see point 6).
4. Always turn or stir the food halfway. Shield if necessary (see point 6).
5. Minced meat, chops and other small items should be broken up or separated and placed in a single layer.
6. Shielding prevents food from cooking. It is essential when defrosting chickens and joints of meat.
The outside thaws out first, so protect wings/breast/fat/bones with smooth pieces of aluminium foil secured with cocktail sticks.
7. Allow standing time so that the centre of the food thaws out (minimum of 1 hour for joints of meat and whole chickens).



Arrange food in a single layer.



Turn or break up food as soon as possible.



Shield chickens and joints of meat.

Auto reheat/auto cook









Press a desired Auto Reheat/ Auto Cook pad several times until the appropriate weight appears.

Press Start.
The time counts down in the display.

■ Notes



1. Only use the accessories as indicated below.
2. Large pieces of fish/meat in a thin sauce, may require longer cooking.
3. These programs are not suitable for foods that cannot be stirred.
4. Meals in bowl shaped containers will need extra cooking time.
5. As some variations may occur in food, check that food is thoroughly cooked and piping hot before serving.

Auto Reheat

Programme	Instructions
	Weight: 200-800 g Accessories:  For reheating a curry convenience meal that can be stirred. Foods must be in a suitable single section microwaveable container and have the film pierced. Place it on the glass tray. Press Curry several times until the appropriate weight appears, and press Start. Stir at beeps. Allow to stand for 1 minute. Ensure the food is piping hot. Stir the food before serving.
	Weight: 200-500 g Accessories:  For reheating a Chinese style convenience meal that can be stirred. Foods must be in a suitable single section microwaveable container and have the film pierced. Place it on the glass tray. Press Chinese several times until the appropriate weight appears, and press Start. Stir at beeps. Allow to stand for 1 minute. Ensure the food is piping hot. Stir the food before serving.
	Weight: 200-800 g Accessories:  For reheating a pasta style convenience meal that can be stirred. Foods must be in a suitable single section microwaveable container and have the film pierced. Place it on the glass tray. Press Pasta several times until the appropriate weight appears, and press Start. Stir at beeps. Allow to stand for 1 minute. Ensure that the food is piping hot. Stir the food before serving.

Auto programmes

Auto Cook

Programme	Instructions
<p data-bbox="191 288 269 331">Jacket Potatoes</p>	<p data-bbox="353 228 997 387">Weight: 200-1000 g Accessories: </p> <p data-bbox="353 256 997 387">For cooking jacket potatoes. Choose medium sized potatoes 200-250 g (7-9 oz). Wash and dry and prick with a fork several times. Arrange around the edge of glass tray. Press Jacket Potatoes several times until the appropriate weight appears, and press Start. DO NOT COVER.</p>
<p data-bbox="191 480 269 523">Fresh Vegetables</p>	<p data-bbox="353 403 997 427">Weight: 100-1000 g Accessories: </p> <p data-bbox="353 435 997 592">For cooking FRESH vegetables. Place prepared vegetables into a shallow container on the glass tray. Add 15 ml (1 tbsp) of water per 100 g of vegetables. Cover with pierced cling film or lid. Press Fresh Vegetables several times until the appropriate weight appears, and press Start. Stir/rearrange if necessary when the oven beeps.</p>
<p data-bbox="191 663 269 707">Fish</p>	<p data-bbox="353 604 997 628">Weight: 200-800 g Accessories: </p> <p data-bbox="353 636 997 767">For cooking FRESH fish. Shield the thinner portions. Place in a shallow container on the glass tray. Add 15-45 ml (1-3 tbsp) of liquid. Cover with pierced cling film or lid. Press Fresh Fish several times until the appropriate weight appears, and press Start.</p>

Defrosting charts

The time given below is a guideline only. Always check the progress of the food by opening the oven door and then re-starting. For larger quantities adjust the time accordingly. Food should not be covered during defrosting.

[Microwave power level: Defrost (270 W)]

Meat	Weight	Defrosting Time	Instructions	Standing Time
Beef/Lamb/ Pork Joint	450 g (1 lb)	5-7 mins.	Place in a suitable dish or on an upturned saucer or use a rack. Turn 3-4 times. Shield.	60 mins.
Minced Beef	450 g (1 lb)	8 mins. 30 secs. -11 mins.	Place in a suitable dish. Break up and turn 3-4 times.	15 mins.
Chops	450 g (1 lb)	6-7 mins.	Place in a suitable dish in a single layer. Turn twice. Shield if necessary.	15 mins.
Sausages	450 g (1 lb)	4 mins.	Place in a suitable dish in a single layer. Turn twice. Shield if necessary.	15 mins.
Bacon Rashers	450 g (1 lb)	5-6 mins.	Place in a suitable dish. Turn and separate twice. Shield if necessary.	10 mins.
Stewing Steak	450 g (1 lb)	7-9 mins.	Place in a suitable dish. Break up frequently.	15 mins.
Whole Chicken	450 g (1 lb)	6-7 mins.	Place in a suitable dish on an upturned saucer or use a rack. Turn 3-4 times. Shield.	60 mins.
Chicken Portions	450 g (1 lb)	5 mins. 30 secs. -7 mins.	Place in a suitable dish in a single layer. Turn twice. Shield if necessary.	15-30 mins.
Fish	Weight	Defrosting Time	Instructions	Standing Time
Whole	450 g (1 lb)	6-7 mins.	Place in a suitable dish. Turn twice. Shield.	15 mins.
Fillet/steak	450 g (1 lb)	6-7 mins.	Place in a suitable dish. Turn twice, separate and shield if necessary.	15 mins.
Prawns	450 g (1 lb)	6-7 mins.	Place in a suitable dish. Stir twice during defrosting.	10 mins.
General	Weight	Defrosting Time	Instructions	Standing Time
Bread Sliced	400 g (14 oz)	1 min. 30 secs. -2 mins.	Place on the glass tray. Separate and rearrange during defrosting.	10 mins.
Slice of bread	30 g (1 oz)	10-20 secs.	Place on the glass tray on a piece of kitchen paper.	1-2 mins.
Pastry	450 g (1 lb)	1 min. 30 secs. + rest 1 min. 1 min. 30 secs.	Place on a plate. Turn over after 1 min. resting time.	10-15 mins.
Soft Fruit	450 g (1 lb)	7-8 mins.	Place in a suitable dish. Stir twice during defrosting.	10 mins.

Reheating charts

The time given in the charts below is a guideline only, and will vary depending on STARTING temperature, dish size etc.

Food	Weight/ Quantity	Power Level	Cooking Time (approx.)	Instructions
BREAD – Precooked – Fresh – N.B. Breads reheated by Microwave will have a soft base.				
Croissants	2	High	20-30 secs.	Place on microwave safe plate on glass tray. Do not cover.
	4	High	40-50 secs.	
Rolls	1	High	10 secs.	
	4	High	20 secs.	
CANNED BEANS, PASTA				
Baked Beans, Ravioli in sauce	200 g	High	2-3 mins.	Place in a microwave safe bowl. Cover and place on glass tray. Stir halfway.
	420 g	High	4-5 mins.	
Spaghetti in Tomato Sauce	200 g	High	2½-3 mins.	
CANNED SOUPS				
Cream of Tomato	400 g	High	3-4 mins.	Place in a microwave safe bowl. Cover and place on glass tray.
Minestrone	400 g	High	2½-3 mins.	
CANNED PUDDINGS				
Creamed Rice	425 g	High	3-3½ mins.	Place in a microwave safe bowl. Cover and place on glass tray.
	624 g	High	4-5 mins.	
Sponge Pudding	300 g	High	2½ mins.	
CHRISTMAS PUDDINGS – Overheating may cause pudding to ignite				
Slice	150 g	High	20-30 secs.	Place in a microwave safe dish. Cover and place on glass tray.
Small	450 g	High	1½-2 mins.	
Medium	900 g	High	2½-3 mins.	
DRINKS – COFFEE				
1 mug	235 ml	High	2 mins.	Place in a microwave safe mug on glass tray. Stir, before, during and after reheating.
2 mugs	470 ml	High	3½ mins.	
DRINKS – MILK				
1 mug	235 ml	High	1-1½ min.	Place in a microwave safe mug on glass tray. Stir, before, during and after reheating.
1 jug	600 ml	High	5 mins.	

■ Note Always check that food is piping hot after reheating in the microwave. If unsure, return to oven. Foods will still require STANDING TIME, especially if they cannot be stirred. The denser the food, the longer the standing time.

Food	Weight/ Quantity	Power Level	Cooking Time (approx.)	Instructions
PASTRY PRODUCTS – PRECOOKED – N.B. Pastries reheated by microwave will have a soft base.				
Chicken Pie	600 g	High	4-4½ mins.	Place on microwave safe plate on glass tray. Do not cover.
Cornish Pasty	227 g (1)	High	2-2½ mins.	
Quiche	400 g (1)	High	4½-5 mins.	
Steak & Kidney Pie	325 g (1)	High	2-2½ mins.	
Sausage Rolls	260 g (4)	High	1½-2 mins.	Place on microwave safe plate on glass tray. Do not cover. Turn halfway.
Samosas	200 g (4)	High	1½-2 mins.	
Spring Rolls	230 g (4)	High	2-2½ mins.	
Christmas Mince Pies	90 g (2)	High	10 secs.	Place on a microwave safe plate on glass tray.
PLATED MEALS – HOMEMADE – CHILLED				
Child Size	1	High	3-4 mins.	Place on a microwave safe plate on glass tray. Cover and place on glass tray.
Adult Size	1	High	5½-6 mins.	
PUDDINGS & DESSERTS N.B. Transfer food from foil containers to a similar sized microwave safe dish.				
Bread & Butter Pudding	395 g	High	3-3½ mins.	Place in a microwave safe dish on glass tray. Do not cover.
Fruit Crumble	600 g	High	3½-4 mins.	
Fruit Pie, individual	1	High	20-30 secs.	
	4	High	50-60 mins.	
Rice Pudding	400 g	High	2-2½ mins.	Place in a microwave safe dish. Cover and place on glass tray.
PURCHASED CONVENIENCE FOODS – CHILLED N.B. Transfer food from foil container to a similar sized microwave safe dish. Plastic dishes designed for microwave and conventional ovens may be used with care.				
Cauliflower Cheese	450 g	High	5½-6 mins.	Place in microwave safe dish on glass tray. Do not cover.
Cottage Pie	450 g	High	6 mins.	
Lasagne	400 g	High	4½-5 mins.	
Vegetable Bake	400 g	High	5½-6 mins.	

■ Note Always check that food is piping hot after reheating in the microwave. If unsure, return to oven. Foods will still require STANDING TIME, especially if they cannot be stirred. The denser the food, the longer the standing time.

Reheating charts

Food	Weight/ Quantity	Power Level	Cooking Time (approx.)	Instructions
PURCHASED CONVENIENCE FOODS – FROZEN N.B. Transfer food from foil container to a similar sized microwave safe dish. Plastic dishes designed for microwave and conventional ovens may be used with care.				
Lasagne	400 g	High	4½-5 mins.	Place in a microwave safe dish on glass tray. Do not cover.
		+ Rest.	1 min.	
		+ High	5-5½ mins.	
Salmon Crumble	340 g	High	5½ mins.	
		+ Rest.	1 min.	
		+ Medium	5½-6 mins.	
Shepherd's Pie	460 g	High	5½ mins.	
		+ Rest.	1 min.	
		+ Medium	6-7 mins.	

■ **Note** Always check that food is piping hot after reheating in the microwave. If unsure, return to oven. Foods will still require **STANDING TIME**, especially if they cannot be stirred. The denser the food, the longer the standing time.

Cooking charts

Food	Weight/ Quantity	Power Level	Cooking Time (approx.)	Instructions
BACON – from raw				
Rashers	130 g (4)	High	2-3 mins. (or 30-40 secs per rasher)	Place on microwave safe rack or plate on glass tray.
BEANS & PULSES – should be pre-soaked (except lentils)				
Chick Peas	225 g	High + Low	8½ mins. 35-40 mins.	Use 600 ml (1 pt) boiling water in a large bowl. Cover and place on glass tray.
Lentils	225 g	Low	10½-13 mins.	
Red Kidney Beans	225 g	High	13 mins.	Use 600 ml (1 pt) boiling water in a large bowl. Cover. Must boil for at least 12 minutes to destroy toxic enzymes.
		+ Low	30-35 mins.	

■ **Note** Always check that food is piping hot after reheating in the microwave. If unsure, return to oven. Foods will still require **STANDING TIME**, especially if they cannot be stirred. The denser the food, the longer the standing time.

Food	Weight/ Quantity	Power Level	Cooking Time (approx.)	Instructions	
BEEF – Joints from raw – Caution: Hot fat! Remove dish with care.					
Medium	per 450 g (1 lb)	Medium	7-12 mins.	Place on upturned saucer in microwave safe dish or rack on glass tray. Cover and turn halfway. Drain off fat during cooking.	
CHICKEN from raw – Caution: Hot fat! Remove dish with care.					
Breasts, boneless	500 g	Low	10½-12 mins.	Place on microwave safe rack or plate. Cover and place on glass tray.	
Drumsticks	450 g (4)	Low	10½ mins.		
Quarters	700 g (2)	Low	16-17 mins.		
Whole	per 450 g (1 lb)	High	8½-9 mins.	Place on upturned saucer breast side down in microwave safe dish. Cover and place on glass tray.	
EGGS – Poached.					
Water	45 ml	High	40-50 secs.	<ul style="list-style-type: none"> • Place water in a small bowl and heat for 1st cooking time. • Add egg (medium sized). • Pierce yolk and white. • Cover. • Cook for 2nd cooking time. • Then leave to stand for 1 min. 	
Egg	1	High	20-30 secs.		
Water	90 ml	High	50 secs.		
Eggs	2	High	40-50 secs.		
EGGS – Scrambled.					
Egg	1	High + Stir. + High	20-30 secs. 20 secs.	<ul style="list-style-type: none"> • Add 1 tbsp of milk for each egg used. • Beat eggs, milk and knob of butter together. • Cook for 2nd cooking time then stand for 1 min. 	
Eggs	2	High + Stir. + High	40-50 secs. 30-40 secs.		
FISH – FRESH from raw					
Haddock Fillets	380 g (4)	High + Medium	4½ mins. 4½-5½ mins.		Place in microwave safe dish. Add 30 ml of liquid. Cover and place on glass tray.
Whole	450 g (2)	High	8½-10½ mins.		
Boil in the Bag	170 g (1)	Defrost + rest + Low	4½ mins. 2 mins. 5½ mins.	Place bag sauce side down on a microwave safe plate. Slash top of bag with a knife.	

■ **Note** Always check that food is piping hot after reheating in the microwave. If unsure, return to oven. Foods will still require **STANDING TIME**, especially if they cannot be stirred. The denser the food, the longer the standing time.

Cooking charts

Food	Weight/ Quantity	Power Level	Cooking Time (approx.)	Instructions
FRUIT – Peel, slice, chop into even sized pieces. Place in shallow microwave safe dish.				
Apples, Rhubarb, stewed	450 g	High	4½-8 mins.	Only half fill dish. Cover. Stir halfway.
Plums – stewed	450 g	High	7-8 mins.	Add 30 ml (2 tbsp) of water. Only half fill dish. Cover and place on glass tray.
LAMB – from raw – CAUTION: Hot Fat! Remove dish with care.				
Chops, loin	per 450 g (1 lb)	High ----- + Low	1½-2½ mins. ----- 2-3 mins.	Place on microwaveable safe dish or rack. Cover and place on glass tray.
Joints	per 450 g (1 lb)	High ----- + Low	3-4 mins. ----- 6-7 mins.	Place on upturned saucer in microwave safe dish or rack on glass tray. Cover and turn joint over halfway. Drain off fat during cooking.
PASTA – Place in a large 3 litre (6 pint) microwave safe bowl.				
Macaroni	225 g	High	12 mins.	Use 1 litre (1¾ pint) boiling water. Cover and place on glass tray.
Spaghetti, Tagliatelli	225 g	High	7-8½ mins.	
PIZZA – FRESH CHILLED – N.B. Remove all packaging. Pizzas will have a soft base.				
Thin & Crispy	400 g	High	4½-5 mins.	Place on heatproof plate on glass tray. Do not cover.
Deep Pan	475 g	High	3½-4½ mins.	
PORK – from raw – CAUTION: Hot Fat! Remove dish with care.				
Chops	360 g (2)	High ----- + Low	2-3 mins. ----- 6-7 mins.	Place in microwave safe dish or rack on glass tray. Cover and place on glass tray.
Joints	per 450 g (1 lb)	High ----- + Low	5½-6 mins. ----- 8-9 mins.	Place on upturned saucer in microwave safe dish or rack. Cover and place on glass tray. Turn joint over halfway. Drain off fat during cooking.
PORRIDGE – N.B. Use a large bowl.				
1 serving	½ cup oats	High	2½-3 mins.	Add 1 cup of water or milk. Stir halfway.
2 servings	1 cup oats	High	4-5 mins.	Add 2 cups of water or milk. Stir halfway.

■ Note Always check that food is piping hot after reheating in the microwave. If unsure, return to oven. Foods will still require **STANDING TIME**, especially if they cannot be stirred. The denser the food, the longer the standing time.

Food	Weight/ Quantity	Power Level	Cooking Time (approx.)	Instructions
RICE – Place in a large microwave safe bowl. 3 litre (6 pint)				
Basmati	250 g	Low	10½-11½ mins.	Use 600 ml (1 pt) to 800 ml (1½ pt) boiling water. Cover and place on glass tray.
Easycook White	250 g	High	10½-11½ mins.	
SAUSAGES from raw – CAUTION: HOT FAT! Remove dish with care.				
Thick	240 g (4)	High	2½-3 mins.	Place on microwave safe plate or microwave rack. Cover and place on glass tray.
Thin	110 g (4)	High	1½-2 mins.	
FRESH VEGETABLES – Place in shallow microwave safe dish.				
Green Beans	450 g	High	6-7 mins.	Add 90 ml (6 tbsp) water. Cover and place on glass tray.
Beetroot	450 g	High	8½-10½ mins.	
Broccoli + Cauliflower – florets	450 g	High	7-8½ mins.	
Brussel Sprouts	450 g	High	7-8 mins.	
Cabbage – sliced	450 g	High	6-8 mins.	
Carrots, Leeks	450 g	High	6-7 mins.	
Corn on the Cob	450 g	High	6-8 mins.	
Courgettes, Mange Tout	450 g	High	3½-4½ mins.	
Peas	450 g	High	3½-5½ mins.	
Potatoes – boiled	450 g	High	5½-6 mins.	
Potatoes – jacket (225 g / 8 oz each)	1	High	4½ mins.	Wash and prick skins. Place directly on glass tray on outer edge. After cooking stand for 5 mins wrapped in foil.
	2	High	7 mins.	
FROZEN VEGETABLES – Place in shallow microwave safe dish.				
Beans – green, Carrots	450 g	High	8½-10 mins.	Add 30 ml (2 tbsp) water. Cover and place on glass tray.
Cauliflower	450 g	High	10½ mins.	
Peas	450 g	High	7-8 mins.	

■ Note Always check that food is piping hot after reheating in the microwave. If unsure, return to oven. Foods will still require **STANDING TIME**, especially if they cannot be stirred. The denser the food, the longer the standing time.

Recipes

Soup and Snacks

Cream of Mushroom Soup

Serves 4

Dish: large bowl

1. Place the butter and chopped onion in a large bowl. Cover and cook on High power for 3 mins or until soft.
2. Add the stock, mushrooms and bouquet garni. Cover and cook on High power for 11-13 mins, or until mushrooms are soft.
3. Remove the bouquet garni and blend until smooth. Mix the cornflour with a little of the milk, then stir in remaining milk. Add to the mushroom mixture.
4. Cover and cook on High power for 4½-5½ mins, or until thickened. Season and serve with cream swirled on top.

Ingredients

25 g (1 oz) butter
1 small onion, chopped
600 ml (1 pt) hot chicken stock
225 g (8 oz) button mushrooms, sliced
bouquet garni
15 ml (1 tbsp) cornflour
300 ml (½ pt) milk
salt and pepper
60 ml (4 tbsp) single cream

Macaroni Cheese with Courgettes and Bacon

Serves 2

Dish: 20 cm (8") casserole

1. Cover and cook macaroni in 450 ml (¾ pt) boiling water on High power for 8½ mins, or until soft. Drain.
2. Place courgettes and bacon in a bowl. Cover and cook on High power for 3-4 mins, or until soft. Drain.
3. Place the butter in a large jug. Cook on High power for 40-50 secs. Stir in the flour and cook for 30-40 secs, on High power. Gradually add milk, stir well and cook on High power for 4-4½ mins. or until the sauce is thick and bubbling. Stir frequently.
4. Add mustard and cheese. Mix in the macaroni, courgettes and bacon. Season and pour into a casserole dish, sprinkle over the topping and cook on High power for 3-4 mins. or until the cheese has melted.

Ingredients

100 g (4 oz) quick cook macaroni
225 g (8 oz) courgettes, sliced
100 g (4 oz) bacon, chopped
50 g (2 oz) butter
50 g (2 oz) plain flour
600 ml (1 pt) milk
100 g (4 oz) cheese, grated
5 ml (1 tsp) mustard
salt and pepper

Topping

30 ml (2 tbsp) Parmesan cheese
30 ml (2 tbsp) wholemeal breadcrumbs

Lentil Biryani

Serves 2

Dish: large casserole

1. Soak the lentils in cold water for 1 hour then drain.
2. Place the oil and onion in a large bowl. Cover and cook on High power for 3-4 mins. or until softened.
3. Add the ginger, garlic, turmeric, chilli and curry powder. Cover and cook on High power for 2 mins.
4. Add the yoghurt, mushrooms, tomatoes, water and lentils. Cover and cook on High power for 13-17 mins. or until the lentils are tender and the liquid has evaporated.
To cook rice: add 350 ml boiling water to rice in large bowl and cook on High power, covered, for 13 mins. stirring halfway.
5. Add the lentil mixture and cashew nuts to the cooked rice and mix thoroughly. Reheat on High power if necessary to ensure food is piping hot. Garnish and serve.

Ingredients

50 g (2 oz) green lentils
10 ml (2 tsp) oil, 1 small onion, sliced
3 ml (½ tsp) grated root ginger
1 garlic clove, crushed
3 ml (½ tsp) turmeric
3 ml (½ tsp) chilli powder
5 ml (1 tsp) curry powder
150 ml (¼ pt) natural yoghurt
50 g (2 oz) mushrooms, sliced
2 tomatoes, peeled and chopped
150 ml (¼ pt) hot water
25 g (1 oz) cashew nuts
225 g (8 oz) cooked basmati rice

Garnish

hard boiled egg slices and
coriander leaves

Meat and Poultry

Lamb in a Spicy Cream and Almond Sauce

Serves 4

Dish: large casserole dish

1. Mix together the garlic, ginger, almonds and water to make a thick paste.
2. Place the cardamom pods, cloves, cinnamon, onion and oil in the casserole dish cook on High power for 3 mins.
3. Add the lamb and cook for 4½ mins. on High power or until light brown in colour. Stir halfway.
4. Stir in the rest of the spices, the almond mixture, cream, salt and pepper. Cover and cook on Low power for about 35-40 mins. or until the meat is tender. Stir the casserole 2-3 times during the cooking time.
5. Remove the whole cardamom pods, cloves and cinnamon before serving with rice or other vegetables.

Ingredients

3-4 cloves garlic, crushed
1 cm (¼") piece fresh ginger, grated
50 g (2 oz) ground almonds
45 ml (3 tbsp) water
3 whole cardamom pods
2 cloves
2.5 cm (1") stick of cinnamon
1 onion chopped
30 ml (2 tbsp) oil
450 g (1 lb) boned lamb, trimmed and cut into cubes
5 ml (1 tsp) ground coriander
5 ml (1 tsp) ground cumin
1.5 ml (¼ tsp) garam masala
1.5 ml (¼ tsp) cayenne pepper
150 ml (¼ pt) single cream
salt and pepper

Recipes

Chicken Casserole

Serves 4

Dish: 3 litre (6 pt) casserole

1. Place vegetables and butter in dish. Cover and cook on High power for 4-6 mins. or until soft.
2. Place chicken on top of vegetables, cover with stock and tomatoes and add salt and pepper to taste.
3. Cover and cook on High power for 4½ mins. then Low power for 30-35 mins. or until well cooked through.
4. Mix cornflour with a little water. Remove chicken from casserole, skim off excess fat and stir in cornflour paste. Cook on High power for 2 mins. Serve chicken with sauce poured over.

N.B. If diced boneless breast is used in place of the quarters, reduce 2nd cooking time to 10-14 mins. on Low power or until well cooked through. Stir halfway.

Ingredients

25 g (1 oz) butter
2 medium onions, sliced
2 sticks celery, trimmed and chopped
100 g (4 oz) mushrooms, sliced
4 chicken quarters, skinned
300 ml (½ pt) hot chicken stock
300 g (11 oz) can tomatoes
salt and pepper
30 ml (2 tbsp) cornflour

Pork with Sweet & Sour Sauce Serves 2

Dish: small casserole

1. Place pork in dish, cover and cook on Low power for 7-9 mins. or until juices run clear.
2. Place oil, carrot, onion and green pepper in a bowl. Cover and cook on High power for 2-3 mins. or until vegetables are tender.
3. Mix half the reserved juice with the remaining ingredients except pineapple. Cover and cook on High power for 2-3 mins. or until clear and thickened. Stir halfway.
4. Add the sauce to the vegetables. Stir in the pineapple. Mix well.
5. Cook on High power for 1 min. or until heated through. Spoon over cooked pork. Reheat for 1-2 mins. on High power or until piping hot.

Ingredients

225 g (8 oz) pork fillet, diced
Sweet & Sour Sauce:
15 ml (1 tbsp) oil
1 small carrot cut into matchsticks
1 spring onion, thinly sliced
small green pepper, cut into strips
225 g (8 oz) can pineapple chunks, drained (reserve juice)
10 ml (2 tsp) soft brown sugar
5 ml (1 tsp) cornflour
pinch garlic salt
5 ml (1 tsp) cider vinegar
10 ml (2 tsp) soy sauce
5 ml (1 tsp) tomato ketchup

Savoury Mince

Serves 2

Dish: 1.5 litre (3 pt) casserole dish

1. Place onion, garlic and oil in casserole, cover and cook on High power for 2-3 mins. or until soft.
2. Place all other ingredients in casserole. Stir well.
3. Cover and cook on High power for 4½ mins. then Low power for 15-20 mins. or until the meat is cooked.

Ingredients

1 small onion, diced
1 clove garlic, crushed
5 ml (1 tsp) oil
200 g (7 oz) can chopped tomatoes
15 ml (1 tbsp) tomato puree
5 ml (1 tsp) mixed herbs
225 g (8 oz) minced beef
salt and pepper

Chicken Satay

Serves 2

Dish: 4 wooden skewers + shallow dish

1. For the serving sauce: Crumble 25 g (1 oz) of creamed coconut into a large jug. Add the peanut butter, 15 ml (1 tbsp) of the lemon juice, 15 ml (1 tbsp) of the soy sauce, the chilli powder and 150 ml (¼ pt) water. Cook on High power for 3-4 mins. or until the sauce boils and thickens, stirring frequently. Turn into a serving bowl.
2. Cut the chicken into small chunks and place in a bowl. Put the remaining creamed coconut, lemon juice and soy sauce into a blender or food processor. Add the remaining ingredients and blend until smooth.
3. Pour over the chicken. Cover and marinate in the fridge for 2-3 hours or overnight.
4. Thread the chicken onto wooden skewers. Place in a shallow dish, cover with any remaining marinade and cook covered on High power for 5½-7 mins. or until cooked, turn and baste frequently. Serve hot with the sauce for dipping.

Ingredients

50 g (2 oz) creamed coconut
45 ml (3 tbsp) crunchy peanut butter
45 ml (3 tbsp) lemon juice
30 ml (2 tbsp) soy sauce
large pinch of chilli powder
150 ml (¼ pt) water
2 chicken breast fillets, skinned
15 ml (1 tbsp) vegetable oil
1 garlic clove, crushed
3 ml (½ tsp) ground turmeric
3 ml (½ tsp) five-spice powder
3 ml (½ tsp) coriander seeds
3 ml (½ tsp) cumin seeds

Recipes

Fish

Arranging

Thin fillets of fish i.e. plaice, should be rolled up prior to cooking to avoid overcooking on the thinner outside edge and tail. Fish steaks should be arranged in a circle, thicker part to the outside. Cover with cling film or lid.

Liquid

Fresh fish should always be sprinkled with 30 ml (2 tbsp) of water, lemon juice or white wine.

When cooking **Frozen** fish, add liquid as above for even cooking. Do not sprinkle salt onto fish before cooking as this may make the fish dry.

Noise

During cooking, popping sounds may be heard. This is due to moisture trapped between the flesh, particularly with oily fish such as salmon and mackerel. This can be minimised when cooking the fish if the skin and flesh is pierced several times with a cocktail stick.

Fish Curry

Serves 2

Dish: casserole dish (1.5 litre (3 pt))

1. Melt the butter in the casserole dish on High power for 30-40 secs. or until melted.
2. Stir in the garlic and onion and cook covered on High power for 3 mins.
3. Stir in the flour, curry powder, lemon rind and juice and fish stock. Cover and cook on High power for 3 mins. stirring halfway through the cooking time.
4. Stir in the remaining ingredients except the coconut, cover and cook on High power for 4-5 mins. or until fish flakes, stirring occasionally.
5. Break up the coconut with a fork, then stir into the curry.

Ingredients

25 g (1 oz) butter
1 clove garlic, crushed
1 small onion, finely chopped
15 ml (1 tbsp) plain flour
15 ml (1 tbsp) curry powder
grated rind and juice of ½ lemon
300 ml (½ pt) hot fish stock
25 g (1 oz) sultanas
10 ml (2 tsp) tomato puree
30 ml (2 tbsp) sweet chutney
450 g (1 lb) haddock, skinned and chopped
salt and pepper
75 g (3 oz) creamed coconut

Family Fish Pie

Serves 4

Dish: large casserole

1. Arrange fish in a shallow dish. Add lemon juice, cover and cook on High power for 3-4 mins. or until it flakes easily.
2. Place onion and oil in a bowl. Cover and cook on High power for 3 mins. or until the onion is soft.
3. Melt the butter on High power for 30-40 secs. Stir in the flour and mustard and cook for a further 20 secs. Add milk and seasoning, gradually stirring to a smooth paste. Cook on High power for 5-6 mins. or until the sauce is thick and bubbling. Stir twice during cooking. Add 75 g (3 oz) of grated cheese to the sauce and stir well.
4. Flake the fish and arrange in the serving dish. Add onions and place the sliced potatoes on top.
5. Pour over the cheese sauce. Sprinkle with breadcrumbs and remaining cheese.
6. Cook on Low power for 10-15 mins. or until the mixture has been completely reheated.

Ingredients

450 g (1 lb) smoked haddock
30 ml (2 tbsp) lemon juice
15 ml (1 tbsp) oil
1 large onion, sliced
600 g (1 lb 5 oz) cooked jacket potatoes, sliced, see page 24
40 g (1½ oz) butter
40 g (1½ oz) flour
3 ml (½ tsp) mustard
600 ml (1 pt) milk
salt and pepper
100 g (4 oz) Red Leicester cheese
75 g (3 oz) wholemeal breadcrumbs

Vegetables

Wild Mushroom and Basil Risotto

Serves 4

Dish: 3 litre (6 pt) casserole dish

1. Soak mushrooms in 300 ml (½ pt) warm water.
2. Place the butter, garlic and onion in a large bowl, cover with cling film and cook on High power for 3-4 mins. or until softened. Season with freshly ground black pepper.
3. Stir the rice into the butter mixture and add the hot stock and soaking liquid from the mushrooms. Cover and cook for a further 4½ mins on High power.
4. Stir the mushrooms into the rice mixture. Cover and cook for a further 4½ mins. on High power.
5. Stir and add the basil. Continue to cook for the final 4½ mins. on High power. Leave to stand for approx. 10 mins. and then stir with a fork.

Ingredients

40 g (1½ oz) dried Cep mushrooms
50 g (2 oz) butter
1 clove garlic, finely chopped
1 small onion, finely chopped
freshly ground black pepper
250 g (8 oz) Arborio rice
300 ml (½ pt) hot vegetable stock
12 basil leaves, torn

Recipes

Vegetable Curry

Serves 2

Dish: 3 litre (6 pt) casserole

1. Sprinkle the aubergine liberally with salt in a colander. Stand for 30 mins. to remove bitter juices. Rinse well under cold water and drain.
2. Combine oil, garlic and spices in the casserole, cover and cook on High power for 2 mins.
3. Add all other ingredients to casserole, except cashews. Cover and cook on High power for 4½ mins. then Low power for 25-30 mins. or until vegetables are soft. Stir occasionally.
4. Sprinkle with cashews and serve with boiled rice.

N.B. This recipe is best cooked in advance, chilled and then reheated to allow the flavours to develop.

Ingredients

1 medium aubergine, diced
salt, 15 ml (1 tbsp) oil
1 clove of garlic, chopped
pinch cayenne pepper
5 ml (1 tsp) ground coriander
3 ml (½ tsp) ground cumin
3 ml (½ tsp) turmeric
2.5 cm (1") root ginger, peeled & sliced
½ small cauliflower, divided into florets
1 medium potato, diced
50 g (2 oz) green beans, sliced
½ fresh chilli, deseeded and sliced
150 ml (¼ pt) vegetable stock
200 g (7 oz) can chopped tomatoes
50 g (2 oz) cashew nuts

Cauliflower Cheese

Serves 2

Dish: large bowl + shallow casserole

1. Place cauliflower upside down in a bowl. Add water. Cover and cook on High power for 7 mins. or until tender. Drain.
2. Melt butter on High power for 30-40 secs. Stir in flour and mustard. Cook for a further 20-30 secs. Add milk gradually. Stir well and season. Cook on High power for 2-3 mins. or until sauce is thick and bubbling. Stir once halfway during cooking.
3. Stir in 50 g (2 oz) grated cheese. Pour the sauce over the cauliflower. Top with remaining cheese and breadcrumbs.
4. Cook on High power for 1-2 mins. or until cheese melts.

Ingredients

1 cauliflower, trimmed and cut into florets
90 ml (6 tbsp) water
25 g (1 oz) butter
25 g (1 oz) flour
3 ml (½ tsp) French mustard
300 ml (½ pt) milk
seasoning to taste

Topping:

75 g (3 oz) grated red cheese
15 ml (1 tbsp) brown breadcrumbs

Desserts / Cakes

Steamed Suet Sponge Pudding

Serves 4

Dish: 1 litre (2 pt) pudding basin

1. In a mixing bowl, sift together the flour and salt. Stir in the sugar and suet.
2. Make a well in the centre and add beaten egg and milk. Mix to a soft dropping consistency.
3. Put the jam in the base of the greased pudding basin and pour pudding mixture over. Cook on High power for 6-7 mins. until firm.

Ingredients

150 g (5 oz) self-raising flour
pinch of salt
50 g (2 oz) caster sugar
50 g (2 oz) suet
1 egg
150 ml (1¼ pt) milk
30 ml (2 tbsp) jam or golden syrup
Optional:
Add 1 tbsp of sultanas to dry ingredients.

Individual Pineapple Upside Down Pudding

Serves 2

Dish: 2 ramekin dishes, base lined

1. Put ½ tbsp golden syrup in the base of each ramekin; arrange pineapple slice and cherry on top of the syrup in the base.
2. Cream together the margarine and sugar until light and fluffy. Beat in the egg gradually. Fold in the flour and mix to a soft consistency with the milk.
3. Spoon the mixture over the pineapple and cook on High power for 3-4 mins. or until cooked. Leave to cool slightly before turning upside down onto a serving plate.

Ingredients

15 ml (1 tbsp) golden syrup
2 pineapple slices, drained
2 glacé cherries
50 g (2 oz) margarine
50 g (2 oz) caster sugar
1 egg
50 g (2 oz) self raising flour
15 ml (1 tbsp) milk

Christmas Puddings

Serves 4

Dish: 4 deep ramekins, base lined

1. Place all ingredients into a large mixing bowl and stir until thoroughly mixed.
2. Divide mixture equally between the ramekins.
3. Place towards outer edge of the glass tray and cook on High power for 4-5 mins. or until cooked.

Ingredients

75 g (3 oz) self-raising flour
3 ml (½ tsp) baking powder
3 ml (½ tsp) mixed spice
25 g (1 oz) butter
1 egg
30 ml (2 tbsp) treacle
60 ml (4 tbsp) stout
15 ml (1 tbsp) rum or brandy
200 g (7 oz) mincemeat
25 g (1 oz) apple, grated
75 g (3 oz) currants
25 g (1 oz) chopped nuts

Recipes

Date Puddings and Butterscotch Sauce

Serves 6

Dish: 3 pint pudding basin

1. Pour 175 ml (6 fl. oz) boiling water over the chopped dates and set aside to cool.
2. Sift together flour and baking powder. Add vanilla and coffee essence to the milk.
3. Cream the butter and sugar until light and fluffy. Add eggs a little at a time.
4. Fold in the flour and flavoured milk, then pour in the date mixture.
5. Place in pudding basin. Cook on High power for 7-8½ mins. and leave to stand for 10 mins.

Sauce

1. Place butter in a large jug and cook on High power for 50 secs. to 1 minute, or until bubbling.
2. Add sugar and stir until it has dissolved, cooking for 1 minute at a time on High power. Continue to cook until liquid is foaming and bubbling 30 secs. at a time on High power.
3. Slowly pour in the cream and bring to the boil on High power for 2-3 mins. Add essence. Stir, continue to boil on High power 30 secs. at a time until it starts to thicken.

Chewy Flapjacks

Dish: 20 cm (8") round dish

1. Place butter, syrup and sugar in a bowl and cook on High power for 1-2 mins. or until melted.
2. Stir in the oats and raisins. Press into dish. Cook on High power for 2-3 mins. or until the centre is bubbling. Allow to cool slightly then cut into 8 pieces.

Ingredients

200 g (7 oz) fresh dates, stoned and finely chopped
175 g (6 oz) self-raising flour
5 ml (1 tsp) baking powder
5 ml (1 tsp) vanilla essence
15 ml (1 tbsp) Camp coffee essence
100 ml (3½ fl. oz) milk
75 g (3 oz) butter
150 g (5 oz) caster sugar
2 eggs lightly beaten

Butterscotch sauce

45 g (1¾ oz) butter
120 ml (8 tbsp) soft brown sugar
200 ml (7 fl. oz) whipping cream
15 ml (1 tbsp) vanilla essence

Ingredients

75 g (3 oz) butter or margarine
30 ml (2 tbsp) golden syrup
75 g (3 oz) light brown sugar
150 g (5 oz) porridge oats
50 g (2 oz) raisins

Boston Brownies

Dish: 20 cm (8") dish lined with greaseproof

1. Place chocolate and butter in a bowl and cook on High power for 1-2 mins. or until chocolate has melted.
2. Stir in all other ingredients and beat well.
3. Pour into dish and cook on Low power for 8-10 mins. or until just slightly sticky. Allow to cool and then cut.

Ingredients

100 g (4 oz) plain chocolate
100 g (4 oz) butter
100 g (4 oz) soft dark brown sugar
100 g (4 oz) self-raising flour
10 ml (2 tsp) cocoa powder
pinch salt
2 eggs, beaten
3 ml (½ tsp) vanilla essence
100 g (4 oz) walnuts, chopped

Sauces

Custard

Dish: 1 litre (2 pt) jug

1. Mix together the custard powder, sugar and a little milk to form a smooth paste.
2. Blend in the remaining milk, whisking well.
3. Cook on High power for 4-5 mins. Whisk well halfway through cooking time and again at the end.

Ingredients

30 ml (2 tbsp) custard power
15 ml (1 tbsp) sugar
600 ml (1 pt) cold milk

White Pouring Sauce

Dish: 1 litre (2 pt) jug

1. Melt butter in jug on High power for 20-40 secs.
2. Stir in the flour to make a roux.
3. Add the milk gradually stirring continuously until well combined.
4. Cook for 3 mins. on High power. Stir and cook for a further 4 mins. Stir and cook for a further 2 mins. Sauce should be smooth and glossy and coat the back of a spoon.

Ingredients

30 g (1 oz) butter
30 g (1 oz) flour
600 ml (1 pt) milk

Recipes

Jam

Soft Fruit Jam Makes approx. 1½ lbs jam

Dish: large bowl

1. Place all ingredients in a large bowl and stir. Cook on High power for 5 mins. (10-15 mins. if using frozen fruit), stirring frequently. Continue to cook in one minute intervals until sugar has dissolved.
 2. Wash down any sugar crystals from around the bowl.
 3. Bring mixture to the boil and continue to cook until setting point is reached – approx. 15-25 mins. Test regularly for setting point.
- N.B.** Do not double this mixture as it will boil over.

Ingredients

450 g (1 lb) soft fruit, washed
450 g (1 lb) caster sugar
30 ml (2 tbsp) lemon juice
5 ml (1 tsp) butter

Cooking and reheating guidelines

Most foods reheat very quickly in your oven by HIGH power. Meals can be brought back to serving temperature in just minutes.

Always check food is piping hot and return to oven if necessary.

As a general rule, always cover wet foods, e.g. soups, casseroles and plated meals.

Do not cover dry foods e.g. bread rolls, mince pies, sausage rolls, etc.

Remember when cooking or reheating any food that it should be stirred or turned wherever possible. This ensures even cooking or reheating on the outside and in the centre.

MINCE PIES - CAUTION

REMEMBER even if the pastry is cold to the touch, the filling will be piping hot and will warm the pastry through. Take care not to overheat otherwise burning can occur due to the high fat and sugar content of the filling. Check the temperature of the filling before consuming to avoid burning your mouth.

PUDDINGS AND LIQUIDS - CAUTION

Puddings and other foods high in fats or sugar, e.g. jam, mince pies, must not be over heated. These foods must never be left unattended as with over cooking these foods can ignite. Take great care when reheating these items.

Do not leave unattended.

Do not add extra alcohol.

BABIES BOTTLES - CAUTION

Milk or formula **MUST** be shaken thoroughly before heating and again at the end and tested carefully before feeding a baby.

For 7-8 fl. oz. of milk from fridge temperature, remove top and teat. Heat on HIGH power for 30-50 secs.

CHECK CAREFULLY BEFORE FEED.

For 3 fl. oz. of milk from fridge temperature, remove top and teat. Heat on HIGH power for 10-20 secs.

CHECK CAREFULLY BEFORE FEED.

N.B. Liquid at top of bottle will be much hotter than at bottom.

The bottle must be shaken thoroughly and tested before use.

WE DO NOT RECOMMEND THAT YOU USE YOUR MICROWAVE TO STERILISE BABIES' BOTTLES.

If you have a special microwave steriliser, we urge extreme caution, due to the low quantity of water involved. It is vital to follow the manufacturers instructions implicitly.

PLATED MEALS

Everyone's appetite varies and reheat times depend on meal contents. Dense items e.g. mashed potato, should be spread out well.

If a lot of gravy is added, extra time may be required.

Place denser items to the outside of the plate. Between 2-4 mins. on HIGH power will reheat an average portion. Do not stack meals.

CANNED FOODS

Remove foods from can and place in a suitable dish before heating.

SOUPS

Use a bowl and stir before heating and at least once through reheat time and again at the end.

CASSEROLES

Stir halfway through and again at the end of heating.

Questions and answers

Q: Why won't my oven turn on?

A: When the oven does not turn on, check the following:

1. Is the oven plugged in securely? Remove the plug from the outlet, wait 10 seconds and reinsert.
2. Check the circuit breaker and the fuse.
Reset the circuit breaker or replace the fuse if it is tripped or blown.
3. If the circuit breaker or fuse is all right, plug another appliance into the outlet. If the other appliance works, there probably is a problem with the oven. If the other appliance does not work, there probably is a problem with the outlet.
If it seems that there is a problem with the oven, contact an authorised Service Centre.

Q: My oven causes interference with my TV. Is this normal?

A: Some radio and TV interference might occur when you cook with the oven. This interference is similar to the interference caused by small appliances such as mixers, vacuums, blow dryers, etc. It does not indicate a problem with your oven.

Q: Sometimes warm air comes from the oven vents. Why?

A: The heat given off from the cooking food warms the air in the oven cavity. This warmed air is carried out of the oven by the air flow pattern in the oven. There are no microwaves in the air. The oven vents should never be blocked during cooking.

Q: Can I use a conventional oven thermometer in the oven?

A: The metal in some thermometers may cause arcing in your oven and should not be used in a microwave oven.

Q: The oven won't accept my programme. Why?

A: The oven is designed not to accept an incorrect programme. For example, the oven will not accept a 4th stage.

Care of your oven

1. The oven should be unplugged before cleaning.
2. Clean the inside of the oven, door seals and door seal areas regularly. When food splatters or spilled liquids adhere to the oven walls, door seals and door seal areas wipe off with a damp cloth. Mild detergent may be used if they get very dirty. The use of harsh detergent or abrasive is not recommended. Avoid cleaning the microwave feed guide area situated on the right hand side of the cavity wall.
DO NOT USE COMMERCIAL OVEN CLEANERS.
3. Do not use harsh, abrasive cleaners or sharp metal scrapers to clean the oven door glass since they can scratch the surface, which may result in shattering the glass.
4. The outside oven surface should be cleaned with a damp cloth. To prevent damage to the operating parts inside the oven, water should not be allowed to seep into the ventilation openings.
5. If the Control Panel becomes dirty, clean it with a soft cloth. Do not use harsh detergents or abrasives on the Control Panel. When cleaning the Control Panel leave the oven door open to prevent the oven from accidentally turning on. After cleaning press Stop/Reset to clear display window.
6. If steam accumulates inside or around the outside of the oven door, wipe with a soft cloth. This may occur when the oven is operated under high humidity conditions and in no way indicates a malfunction of the unit.
7. It is occasionally necessary to remove the glass tray for cleaning. Wash the tray in warm soapy water or in a dishwasher.
8. The roller ring and oven cavity floor should be cleaned regularly to avoid excessive noise. Simply wipe the bottom surface of the oven with mild detergent and hot water then dry with a clean cloth. The roller ring may be washed in mild soapy water. Cooking vapours collect during repeated use but in no way affect the bottom surface or roller ring wheels. After removing the roller ring from the cavity floor for cleaning, be sure to replace it in the proper position.
9. A steam cleaner is not to be used for cleaning.
10. This oven should only be serviced by qualified personnel. For maintenance and repair of the oven contact the nearest authorised dealer.
11. Failure to maintain the oven in a clean condition could lead to deterioration of surfaces that could affect the life of the appliance and possibly result in a hazardous situation.
12. Keep air vents clean at all times. Check that no dust or other material is blocking any of the air vents on the top, bottom or rear of the oven. If air vents become blocked this could cause overheating which would affect the operation of the oven and possibly result in a hazardous situation.

Specifications

Power Source	230-240 V ~ 50 Hz
Power Consumption	5.6 A 1250 W
Output	800 W (IEC-60705)
Outside Dimensions	443 (W) × 330 (D) × 258 (H) mm
Oven Cavity Dimensions	306 (W) × 308 (D) × 214 (H) mm
Overall Cavity Volume	20 L
Glass Tray Diameter	255 mm
Operating Frequency	2450 MHz
Net Weight	11 kg

- Weight and Dimensions shown are approximate.
- Specifications subject to change without notice.
- As for the voltage requirement, the production month, country and serial number, please refer to the identification label on the microwave oven.

Panasonic Warranty (Australia)

Home Appliance 12 Month Warranty from Date of Purchase

1. Subject to the conditions of this warranty Panasonic or its Authorised Service Centre will perform necessary service on the product without charge for parts or labour, if in the opinion of Panasonic, the product is found to be faulty within the warranty period. For Line Communications products (i.e. Cordless Phones, etc) the genuine battery(s) has a 3 month warranty.
2. This warranty only applies to Panasonic products purchased in Australia and sold by Panasonic Australia or its Authorised Distributors or Dealers and only where the products are used and serviced within Australia or its territories. Warranty cover only applies to service carried out by a Panasonic Authorised Service Centre and only if valid proof of purchase is presented when warranty service is requested.
3. This warranty only applies if the product has been installed and used in accordance with the manufacturer's recommendations (as noted in the operating instructions) under normal use and reasonable care (in the opinion of Panasonic). The warranty covers normal domestic use only (also Clip & Trim Professional use) and does not cover damage, malfunction or failure resulting from use of incorrect voltages, incorrect installation, accident, misuse, neglect, build-up of dirt or dust, abuse, maladjustment of customer controls, mains supply problems, thunderstorm activity, infestation by insects or vermin, tampering or repair by unauthorised persons (including unauthorised alterations), exposure to abnormally corrosive conditions or any foreign object or matter having entered the product.
4. This warranty does not cover the following items unless the fault or defect existed at the time of purchase:
 - (a) Cabinet Parts
 - (b) Microwave Oven cook plates.
 - (c) User replaceable Batteries from wear and tear in normal use
 - (d) Kneader mounting shaft unit and Heads, Cutters, Foils, Blades and other accessories.
 - (e) Noise or vibration that is considered normal
5. To claim warranty service, when required, you should:
 - Telephone Panasonic's Customer Care Centre on 132600 or visit our website referred to below and use the Service Centre Locator for the name/address of the nearest Authorised Service Centre.
 - Send or take the product to a Panasonic Authorised Service Centre together with your proof of purchase receipt as a proof of purchase date. Please note that freight and insurance to and/or from your nearest Authorised Service Centre must be arranged by you.
6. The warranties hereby conferred do not extend to, and exclude, any costs associated with the installation, de-installation or re-installation of a product, including costs related to the mounting, de-mounting or remounting of any screen, (and any other ancillary activities), delivery, handling, freight, transportation or insurance of the product or any part thereof or replacement of and do not extend to, and exclude, any damage or loss occurring by reason of, during, associated with, or related to such installation, de-installation, re-installation or transit.

Panasonic Authorised Service Centres are located in major metropolitan areas and most regional centres of Australia, however, coverage will vary dependant on product. For advice on exact Authorised Service Centre locations for your product, please telephone our Customer Care Centre on 132600 or visit our website and use the Service Centre Locator.

In addition to your rights under this warranty, Panasonic products come with consumer guarantees that cannot be excluded under the Australian Consumer Law. If there is a major failure with the product, you can reject the product and elect to have a refund or to have the product replaced or if you wish you may elect to keep the goods and be compensated for the drop in value of the goods. You are also entitled to have the product repaired or replaced if the product fails to be of acceptable quality and the failure does not amount to a major failure.

If there is a major failure in regard to the product which cannot be remedied then you must notify us within a reasonable period by contacting the Panasonic Customer Care Centre. If the failure in the product is not a major failure then Panasonic may choose to repair or replace the product and will do so in a reasonable period of time from receiving notice from you.

**THIS WARRANTY CARD AND THE PURCHASE DOCKET
(OR SIMILAR PROOF OF PURCHASE)
SHOULD BE RETAINED BY THE CUSTOMER AT ALL TIMES**

If you require assistance regarding warranty conditions or any other enquiries, please visit the **Panasonic Australia** website www.panasonic.com.au or contact by phone on **132 600**

If phoning in, please ensure you have your operating instructions available.

Panasonic Australia Pty. Limited

ACN 001 592 187 ABN 83 001 592 187

1 Innovation Road, Macquarie Park NSW 2113

www.panasonic.com.au

PR0-031-F01 Issue: 5.0

01-01-2011

Panasonic Warranty (New Zealand)

Built In Kitchen Appliance 24 Month from Date of Purchase Home Appliance 24 Month Warranty from Date of Purchase

1. Subject to the conditions of this warranty Panasonic or its Authorised Service Centre will perform necessary service on the product without charge for parts or labour, if in the opinion of Panasonic, the product is found to be faulty within the warranty period. For Line Communications products (i.e. Cordless Phones, etc) the genuine battery(s) has a 3 month warranty.
2. This warranty only applies to Panasonic products purchased in New Zealand and sold by Panasonic New Zealand or its authorised Distributors or Dealers and only where the products are used and serviced within New Zealand or its territories. Warranty cover only applies to service carried out by a Panasonic Authorised Service Centre and only if valid proof of purchase is presented when warranty service is requested.
3. This warranty only applies if the product has been installed and used in accordance with the manufacture's recommendations (as noted in the operating instructions) under normal use and reasonable care (in the opinion of Panasonic). The warranty covers normal domestic use only (also Clip & Trim Professional use) and does not cover damage, malfunction or failure resulting from use of incorrect voltages, incorrect installation, accident, misuse, neglect, build-up of dirt or dust, abuse, maladjustment of customer controls, mains supply problems, thunderstorm activity, infestation by insects or vermin, tampering or repair by unauthorised persons (including unauthorised alterations), exposure to abnormally corrosive conditions or any foreign object or matter having entered the product.
4. This warranty does not cover the following items unless the fault or defect existed at the time of purchase:
 - (a) Cabinet Parts
 - (b) Microwave Oven cook plates
 - (c) User replaceable Batteries from wear and tear in normal use
 - (d) Kneader mounting shaft unit and Heads, Cutters, Foils, Blades and other accessories
 - (e) Noise or vibration that is considered normal
 - (f) Correcting the installation (e.g. removal of transit bolts, levelling and locking feet)
 - (g) Damage caused by water pressure exceeding 1MPa
 - (h) Water on floor due to incorrect loading, excessive suds, foreign matter on door seals
 - (i) Blocked pumps and removal filters, removal of foreign objects from the machine (e.g. bra wires, bread tags, nails, screws, coins, grit etc.)
 - (j) Replaceable lint filters
 - (k) Damage to surfaces caused by liquid or solid spillages, impact or lack of maintenance & cleaning products other than that recommended in the operating instructions
 - (l) Consumables (light bulbs, filters)

5. To claim warranty service, when required, you should:
 - Telephone Panasonic's Customer Care Centre on 09 272 0178 or visit our website referred to below and use the Service Centre Locator for the name/ address of the nearest Authorised Service Centre.
 - Send or take the product to a Panasonic Authorised Service Centre together with your proof of purchase receipt as a proof of purchase date. Please note that freight and insurance to and / or from your nearest Authorised Service Centre must be arranged by you.
6. The warranties hereby conferred do not extend to, and exclude, any costs associated with the installation, de-installation or re-installation of a product, including costs related to the mounting , de-mounting or remounting of any screen, (and any other ancillary activities), delivery, handling, freighting, transportation, or insurance of the product or any part thereof or replacement of and do not extend to , and exclude, any damage or loss occurring by any reason of, during, associated with, or related to such installation, de-installation, re-installation or transit.

Panasonic Authorised Service Centres are located in major metropolitan areas and most regional centres of New Zealand, however, coverage will vary dependant on product. For advice on exact Authorised Service Centre locations for your product, please telephone our customer Care Centre on 09 272 0178 or visit our website and use the Service Centre locator.

Unless otherwise specified to the consumer the benefits conferred by this express warranty are additional to all other conditions, warranties, guarantees, rights and remedies expressed or implied by the Consumer Guarantees Act of New Zealand and all other obligations and liabilities on the part of the manufacturer or supplier and nothing contained herein shall restrict or modify such rights, remedies, obligations and liabilities.

**THIS WARRANTY CARD AND THE PURCHASE DOCKET
(OR SIMILAR PROOF OF PURCHASE)
SHOULD BE RETAINED BY THE CUSTOMER AT ALL TIMES**

If you require assistance regarding warranty conditions or any other enquiries, please visit the **Panasonic New Zealand** website www.panasonic.co.nz or contact by phone on **09 272 0178**

If phoning in, please ensure you have your operating instructions available.

Panasonic New Zealand Customer Care Centre

Phone: 09 272 0178

Fax: 09 272 0129

Email: customerservice@nz.panasonic.com

Website: www.panasonic.co.nz/support

Panasonic Corporation

Website: <http://www.panasonic.com>

© Panasonic Corporation 2018

PN:

F0518-0

Printed in China